

# Massa SonAire Model M3 Wireless Ultrasonic Level Sensor

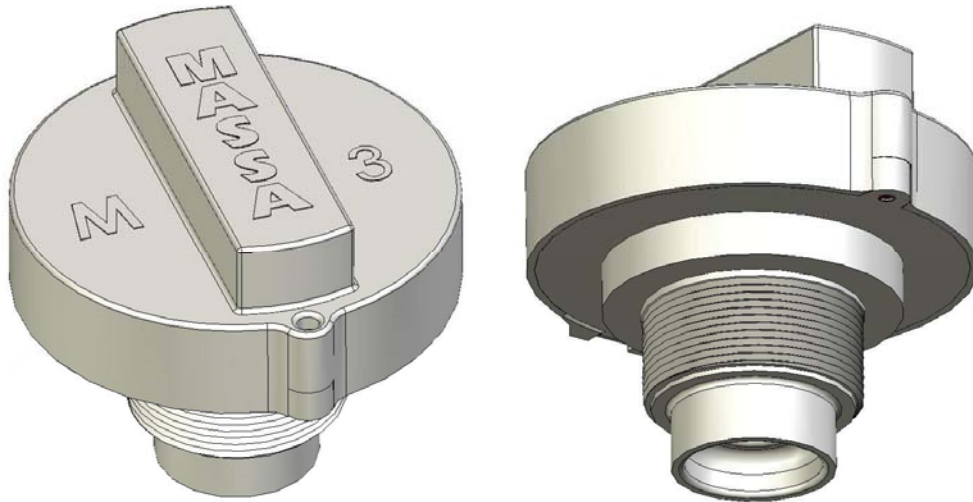

## Developer's Guide

*This document contains proprietary information which is protected by copyright. All rights are reserved. No part of this document may be photocopied, reproduced, or translated without the prior written consent of Massa Products Corporation.*

Copyright © 2016 by Massa Products Corporation. All rights reserved.

**Table of Contents**

<u>Section</u>	<u>Page</u>
<b>1.0 Description and General Operation</b>	<b>2</b>
<b>2.0 Specifications and Dimensions</b>	<b>2</b>
<b>3.0 General Operation</b>	<b>3</b>
<b>4.0 Commissioning Pushbutton</b>	<b>3</b>
<b>5.0 LED Behavior</b>	<b>4</b>
<b>6.0 Data History Buffer</b>	<b>4</b>
<b>7.0 RF Message Format</b>	<b>5</b>
<b>8.0 Sensor Commands</b>	<b>6</b>
<b>9.0 Configuration Registers</b>	<b>14</b>
<b>10.0 Digi’s ConnectPort™ X4 &amp; X8 Gateways and Python Script</b>	<b>19</b>
<b>11.0 Reprogramming Sensor’s Firmware</b>	<b>19</b>
<b>12.0 Getting Started Guide</b>	<b>19</b>
<b>13.0 SonAire M3 Application Software</b>	<b>23</b>
<b>14.0 Sensor Installation Example</b>	<b>29</b>
<b>15.0 Miscellaneous Information</b>	<b>29</b>

**North America**

The SonAire M3 Sensor complies with Part 15 of the FCC Rules. Operation is subject to the following two conditions: (i.) this device may not cause harmful interference and (ii.) this device must accept any interference received, including interference that may cause undesired operation. Contains FCC ID: MCQ-XBEEPRO2, IC: 1846A-XBEEPRO2



**Europe**

The SonAire M3/150CE and Sonaire M3/95CE Sensors comply with European Council EMC Directive 2004/108/EC (EMC) and Low Voltage Directive 2006/95/EC (LVD).



Manufactured under ISO 9001:2008 registered standards

If the equipment is used in a manner not specified by the manufacturer, the protection provided by the equipment may be impaired.

Massa Products Corporation provides this document “as is,” without warranty of any kind, either expressed or implied, including, but not limited to, the implied warranties of fitness or merchantability for a particular purpose. Massa Products Corporation may make improvements and/or changes in this manual at any time. This product could include technical inaccuracies or typographical errors. Changes are periodically made to the information herein; these changes may be incorporated in new editions of the publication.

## 1.0 Description and General Operation

The Massa Model SonAire M-3 Wireless Ultrasonic Sensor consists of a transducer, ultrasonic electronics, ZigBee XBee RF module, microprocessor, and batteries all housed in a weather tight 2” NPT housing. Different models have different sensing ranges. The SonAire M3 can be programmed to automatically obtain and record range, temperature, battery voltage, sensor parameters, and other information at a specified rate. Independent to the ultrasonic acquisition is the operation of the ZigBee radio which can be programmed to sleep for extended periods conserving battery life. When the sensor wakes up from its programmed sleep, it can be programmed to automatically send the acquired ultrasonic data to the gateway or conversely the gateway can request the data when it detects the sensor wakes up. The sensor includes a Commission pushbutton switch used to associate the sensor onto the ZigBee network (if it fails automatically at power up) and a LED is used to identify the operating mode. The package is rated for high pressure wash-down and is accessible for replacing batteries. The sensor is considered an end device in the ZigBee environment.

*NOTE: The sensor does not contain a power switch. If there is a desire to re-boot the sensor, remove one of the batteries, press the sensor’s Commission button, and then re-install the battery. The LED will blink green 3 times indicating it was reset. This procedure is required to discharge circuitry when the sensor is in Deep-Sleep since there is very little current drawn.*

## 2.0 Specifications and Dimensions

### 2.1 Specifications

Models	SonAire M-3/150, SonAire M-3/95 and SonAire M-3/50, see ordering info section for part numbers
Sensor Beam Angle	10 degrees nominal (all models)
*Ultrasonic Sensing Range	SonAire M-3/150: 4” to 7’, M-3/95: 12” to 13’, M-3/50: 14” to 35’
Power	3 Lithium Energizer model L91 AA size 1.5V batteries
Operating Temperature	-30°C to +65°C, relative humidity 0 – 95%, non-condensing
Ultrasonic range response time	Approx 150mS to 500mS
Temperature probe	Internal for speed of sound compensation.
LED	Dual colored. RED: XBee radio active indication. GREEN: power up reset (3 flashes) inductor and if application firmware absent or in reprogramming mode.
Commissioning Pushbutton	Pushbutton switch for associating the sensor onto the Digi gateway when necessary or to wake up sensor. Also used to discharge residual power when battery removed to allow restart.
Housing and Sensor Material	PVDF base, cover, and transducer.
Housing Thread	2” NPT
Housing IP Rating	IP67
Data Acquisition Interval	Programmable acquisition rate from 10 sec to 194 days of Event Data (range, temp, status)
Deep-Sleep Timer	Programmable sleep time from 24 seconds to 24 hours and 0 (disables sleep)
Awake Timer	Programmable awake time after Deep-Sleep period from 12 seconds to 600 seconds
Historical Data (Event Data)	Up to 111 events of sensor data saved in memory including target range, temperature, battery voltage, sensor status, and an Event counter.
Ultrasonic Sensitivity Adjustment	Programmable
Application Firmware	Reprogrammable over the air
Diagnostics	Ultrasonic Waveform Mode that displays reflected ultrasonic signals for application recording purposes or can be used to diagnose more difficult measurement applications.
Radio	Digi’s XBeePRO (p/n XBP24-Z7WIT-004) or XBeePRO for international use (p/n XBP24-Z7WIT-004J).
Radio Range Specifications	XBee: Indoor/Urban Range up to 133 ft. Outdoor RF line-of-sight Range up to 400 ft. XBeePRO: Indoor/Urban Range up to 300 ft. Outdoor RF line-of-sight Range up to 0.7 miles
Radio Firmware	Reprogrammable over the air
Battery Life	3 years nominal dependent on the sleep rate (see Section 15.3)
RoHS	Yes
Weight	1 lb (1.5 lbs for SonAire M3/50)

\*Note: Minimum sensing range increases as temperature increases, however minimum specified range will be reported regardless. See section 15.2 for more information. Maximum range is target dependent.

**2.1 Specifications and Dimensions**

**2.2 Dimensions**

Here is the outline drawing of the sensor. Optional parts include a 2” gasket and 2” NPT nut if sensor is not threaded into a 2” NPT fitting.

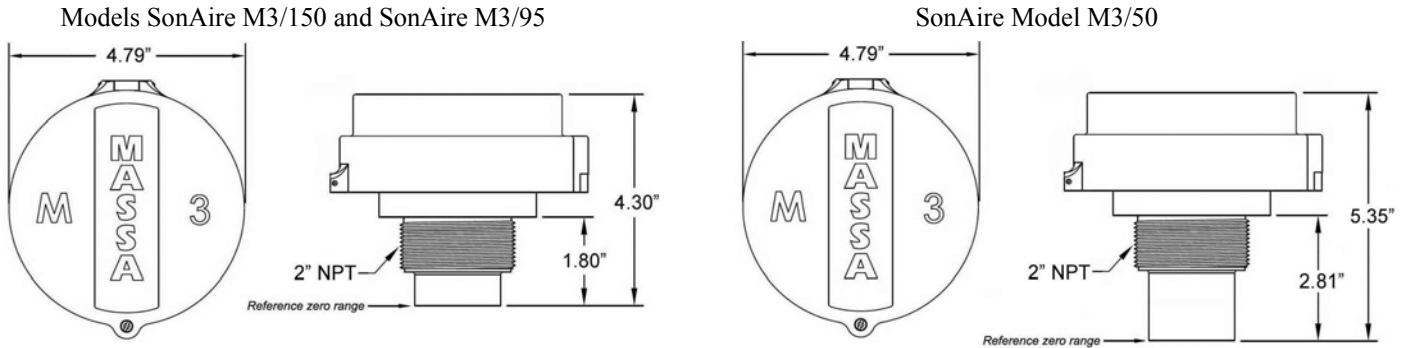

**3.0 General Operation**

The most effective way of setting up the sensor that will conserve battery power is to program it to sleep for a long period followed by a brief awake period where the sensor sends its acquired Event Data (range, temperature, status, etc) automatically to a gateway. This Event data will be stored in memory termed Data History Buffer when set up for automatic acquisition. During this awake period, the gateway in return could send messages to change the sensor settings like stopping the deep-sleep cycle, obtain diagnostic waveform data or other functions like retrieving past recorded events.

Enabling the sensor to automatically acquire Event Data is done by programming the Data Collection Interval register with a non-zero value. Up to 111 of these events (or data acquisitions) can be stored and retrieved later.

It is important to note that the gateway and sensor must have the same PAN ID to communicate with each other on the ZigBee Personal Area Network (PAN) with the exception of assigning sensor ID = 0 (which will associate with any gateway). It is recommended that fixed wireless sensing applications use non-zero PAN IDs so that if another application and gateway is introduced in the area (with its own unique PAN ID), it won't interfere with the first application. If the application utilizes sensors that are roaming and multiple gateways, then keep the factory default sensor PAN ID as zero. This will allow the sensor to join any gateway.

**4.0 Commissioning Pushbutton**

Following is the table for the Commissioning pushbutton switch that is used to associate the sensor onto the ZigBee network. It is also used to wake up the sensor from Deep-Sleep or to discharge the sensor circuitry after a battery is removed when manually rebooting the sensor.

Button Press	Action
Single click	Wakes the sensor for 30 seconds. "Find Me" functionality to find coordinator and sends a Node Identification broadcast transmission.

## 5.0 LED Behavior

Following is the lookup table for the behavior of the LED:

LED Behavior	Description
OFF	No power, battery voltage too low, or sensor sleeping if powered
<b>RED</b> quick flash every 2 seconds	Sensor is joined with a ZigBee network, if stays in this mode, then Deep Sleep = 0.
<b>RED</b> quick flash every 2 seconds followed by an extended OFF period	Sensor is joined to a Zigbee network which then goes to sleep per programmed Awake setting and remains OFF for the programmed Deep Sleep setting.
<b>RED</b> 3 to 50 seconds steady ON	Un-associated state attempting to join ZigBee network.
<b>RED</b> quick flash once a minute	Sensor is not joined to a Zigbee network and the Deep Sleep Timer = 0. Once joined, sensors will quick flash every 2 seconds. May take up to 1 hour to join.
<b>RED</b> multiple blinking	Sensor was requested to read, write, obtain waveforms or other requests.
<b>RED</b> flash every ½ second for 30 seconds	Commission button pressed followed by other behaviors indicated above after 30 sec
<b>GREEN</b> 3 blinks followed by <b>RED</b>	Sensor was rebooted
<b>RED</b> 2 Hz flash, <b>GREEN</b> 1 Hz flash	Error: Application firmware not present

## 6.0 Data History Buffer

### 6.1 Description of data stored in the Data History Buffer

Programming the sensor for stand-alone operation can be done by programming a non-zero value in the Sensor’s “Data Collection Interval” register. This will automatically wake up the sensor at the programmed interval and collect data that includes: ultrasonic range to target, temperature, battery voltage, last radio signal strength level, an event counter, and various status bits. Up to 111 of these data acquisition blocks can be saved into the *Data History Buffer* where it can be retrieved later. The format of the data stored is shown below.

<EventLSB><EventMSB><Status1><Status2><RangeLSB><RangeMSB><TemperatureReading><BatteryReading>

The Event Data bytes defined as follows:

<EventLSB><EventMSB>: 2-byte Event Counter will automatically increment for each new data acquisition

<Status1>: This status byte is parsed as;

<bit7> Sensor Error; 0=OK, 1=Fault (read Configuration Register 65)

<bit6> <bit5> undefined, factory only

<bit4> Ultrasonic Gain Control (short); 0=*Low*, 1=*Hi*

<bit3><bit2> Radio Signal Strength (of Last Reception); 00=*weak*, 01=*moderate*, 10=*strong*, 11=*very strong*

<bit1><bit0> Ultrasonic Signal Target Strength; 00=<25%, 01=50%, 10=75%, 11=100%

<Status2>: This status byte is parsed as;

<bit7><bit6><bit5> Ultrasonic Sensitivity Settings; 000=*Very Low*, 001=*Low*, 010=*Normal (default)*, 011=*Normal-Hi*, 100=*Hi*, 101=*Very Hi*, 110=*Custom*

<bit4><bit3> Ultrasonic Gain Control (long); 0=*Low*, 1=*Hi*, 2=*Time Varying*

<bit2> Temperature Probe; 0=*Internal (default)*, 1=*User Programmed value*

<bit1> Min Distance Processing; 0=*Disabled*, 1=*Enabled (default)*

<bit0> Range Bytes Resolution; 0= ÷ 128 (models M3/150 & M3/95), 1= ÷ 64 (model M3/50)

<RangeLSB><RangeMSB>: Ultrasonic Range (in inches). Resolution for model M3/150 and M3/95: RangeMSB:RangeLSB ÷ 128. Model M3/50: RangeMSB:RangeLSB ÷ 64. **Status2** <bit 0> indicates resolution. No target detected (no echo) is indicated with RangeMSB:RangeLSB=0. RangeMSB = 255 indicates range not acquired (not available in data history buffer).

Temperature (°C) = 0.587085 \* <TemperatureReading> - 50

Battery Voltage (volts) = ( <BatteryReading> - 14 ) / 40

## 7.0 RF Message Format

The XBee Series 2 RF module supports up to 72 bytes of data in its RF packet in addition to the 8 byte MAC address. The message format for the SonAire M3 Sensor is shown below. The message direction is from the host device (PC/gateway) to the SonAire M3 Sensor. *Note that all ZigBee incoming and outgoing messages will be preceded by the radio's MAC address.* The radio's MAC address is the sensor's identifier.

<MAC address>	<DestinationID>	<SenderID>	<Message Length>	<Command>	<Data Byte 1>	<Data Byte 2>	...	<Data Byte n>	<Checksum>
8 byte addr of radio	Sensor ID default=1	Host ID default=251	x	x	x	x		x	checksum

Sensor ID values are defined from 1 to 250 and typically will be set to 1 with the radio's MAC address being the primary sensor identifier. The Host ID values are defined from 251 to 255 with 251 being the typical value. Address bytes in the message will follow the Command byte in Data Byte 1 (LSB) and Data Byte 2 (MSB).

The sensor's response message will return through the Digi Gateway. Here is the format of the message seen by the host device.

<DestinationID>	<SenderID>	<Message Length>	<Command>	<Data Byte 1>	<Data Byte 2>	...	<Data Byte n>	<Checksum>
Host ID default=251	Sensor ID default=1	x	x	x	x		x	checksum

**DestinationID:** This byte represents the destination ID for the message. If the message is going to a sensor from a host device, then the values will be from 1 to 250 with the default value of 1. If the message is being set to a host device from a sensor, then the values will be from 251 to 255 with the default value of 251.

**SenderID:** This byte represents the sender's ID for the message. If the message is going to a sensor from a host device, the values will be from 1 to 250 with the default value of 1. If the message is being set to a host device from a sensor, then the values will be from 251 to 255 with the default value of 251.

**Message Length:** This will contain the total number of bytes in the message not including the MAC address.

**Data Bytes:** These bytes contain the data that will be transferred to and from the sensor. If specific commands require an address like reading and writing to Configuration Registers, Data Byte 1 will contain the LSB address and Data Byte 2 will contain the MSB address.

**Checksum:** This is the sum of all bytes (not including MAC address) modulo 256

**8.0 Sensor Commands****8.1 Sensor Command Codes**

The table below contains command codes for accessing sensor information and configuring various sensor settings. This includes reading the sensor event data (or past historical data), acquiring the ultrasonic waveform, reading or writing the configuration data, and other commands. For the response and examples of the communications between a host device and sensor, see section 8.2.

The sensor can be tailored to operate in various applications by adjusting these settings. See section 9 for parameters that affect operation such as ultrasonic acquisition interval or adjusting sensor thresholds.

**Summary**

<b>Command #</b>	<b>Command Title</b>	<b>Description</b>
1	<i>Read Event Data from the History Buffer</i>	Reads saved data in sensor
2	<i>Acquire New Event Data w/out recording to the Data History Buffer</i>	Request to acquire new data
3	<i>Acquire New Event Data and record to the Data History Buffer</i>	Request to acquire new data
10	<i>Acquire Ultrasonic Waveform</i>	Record ultrasonic waveform in memory
25	<i>Write to Configuration Registers</i>	Save configuration values in sensor memory
35	<i>Read Configuration Registers</i>	Read configuration values in sensor memory
100	<i>Request for Misc. Sensor Information</i>	Recall model number, firmware versions, s/n
101	<i>Clear Data History Buffer</i>	Includes resetting the history data pointer and loading all 111 most significant range bytes with 255.
102	<i>Reset Event Counter</i>	Resets the Event Counter to zero
103	<i>Reset Deep-Sleep Timer</i>	Resets the Deep-Sleep Timer
104	<i>Keep XBee Awake</i>	Keep XBee Awake for OTA programming or other operations
199	<i>Reboot (restart) Sensor</i>	Usually after Write requests
200	<i>Acknowledge</i>	Required for several responses
201	<i>Re-send</i>	Used if specific data blocks are not received
202	<i>Checksum Error</i>	Response if data corrupt
247/248/249	<i>Application firmware missing</i>	Response to any command other than reprogramming commands.

**8.2 Sensor Host Commands and Responses from SonAire M3**

The following section will describe the format of commands going to and from the sensor.



**8.2.3.1 Host Command to SonAire M3: Acquire New Event Data and record to Data History Buffer, Command #3**

Like Command #2, Command #3 requests the Sensor to acquire a new measurement and records to the Data History Buffer. The message format is shown below and is sent to the gateway by the host. This command is typically used when the Data Collection Register is 0 (manual mode).

<Destination ID> <Sender ID> <Message Length> <Command> <Checksum>  
 Sensor ID      Host ID      5      3      checksum  
 default=1      default=251

**8.2.3.2 Response to “Acquire New Event Data and record to Data History Buffer” Command #3**

The response to Command #3 is similar to Command #2 but with the measurement recorded to the Event Data History Buffer. Unlike Command #2, this command will reply with Event Data Counter values. The Digi Gateway sends the data to the host device as shown below.

<Destination ID> <Sensor ID> <Message Length> <Command> <Event Data> <Checksum>  
 Host ID      Sensor ID      13      3      see below      checksum  
 default=251      default=1                8 bytes

The format of this 8 byte Event Data block is shown below. See section 6.1 for the definition of each byte.

<EventLSB><EventMSB><Status1><Status2><RangeLSB><RangeMSB><Temperature><BatteryVoltage>

NOTE: The event bytes EventLSB and EventMSB will be retrieved from Sensor memory.

**8.2.4.1 Host Command to SonAire M3: Acquire Ultrasonic Waveform, Command #10**

To acquire an ultrasonic signal profile from the sensor for diagnostic purposes, Command #10 obtains a waveform and stores it in sensor memory. The reply response will be the retrieval of this data and will require 28 RF messages containing the data to complete the transfer (see next section).

The Ultrasonic Waveform operation is controlled by two Configuration Register locations. The sensor gain control is set by Configuration Register 110 and the number of transmit cycles is set by Configuration Register 109. These registers must be set prior to sending Command #10. See sections 9.2.10 and 9.2.11 for the details of these Waveform Configuration Registers. Here is the format of the message which begins the acquisition.

<Destination ID> <Sender ID> <Message Length> <Command> <Checksum>  
 Sensor ID      Host ID      5      10      checksum  
 default=1      default=251

**8.2.4.2 Response to “Acquire Ultrasonic Waveform” Command #10**

In response to Command #10, the sensor collects waveform data and sends back configuration registers, firmware versions, and waveform data. Since the RF message length is limited to 64 bytes, it will take 28 RF messages in total for complete transfer of the data. An “Acknowledge” command from the host device to the sensor will indicate when to send the next block. The initial response from the sensor after the acquire waveform request is to send Data Block #1 followed by subsequent blocks as shown below. If a data block is not received by the host device, a ‘Re-Send’ command can be sent to the sensor.

*Sensor sends a block of 64 data bytes to the Host*

<Destination ID> <Sender ID> <Message Length> <Command> <WaveformBlock#> <data1>...<data64(MSB)> <Checksum>  
 Host ID      Sensor ID      70      10      block #      64 data bytes      checksum  
 default=251      default=1                1 to 28

*Host sends an ‘Acknowledge’ message back to the Sensor after receiving and saving the block of 64 data bytes*

<Destination ID> <Sender ID> <Message Length> <Command> <AcknowledgeToCommand> <Checksum>  
 Sensor ID      Host ID      6      200      10      checksum  
 default=1      default=251           Acknowledge

*Host sends a ‘Resend’ message back to the Sensor if data was corrupt or if it did not receive data*

<Destination ID> <Sender ID> <Message Length> <Command> <ReSendToCommand> < WaveformBlock#> <Checksum>  
 Sensor ID      Host ID      7      201      10      1 to 28      checksum  
 default=1      default=251           Re-Send



**8.2.7.2 Response to “Misc Sensor Information” Command #100**

In response to Command #100, the sensor returns the Sensor model code, Main firmware version, Ultrasonic firmware version, followed by the serial number. Here is the format of this message.

<Destination ID>	<Sender ID>	<Message Length>	<Command>	<SensorModel>	<LSB>	<MSB>	<LSB>	<MSB>	<LSB> . . . <MSB>	<Checksum>
Host ID	Sensor ID	14	100	model code	Main FW	Ultrasonic FW	serial number	checksum		
default=251	default=1			(see below)	version	version	4 bytes			

Model Codes: Model M-3/150 = 50, Model M-3/95 = 51, M3/150is = 52, M3/95is = 53, M3/50 = 54

**8.2.8.1 Host Command to SonAire M3 and Response: Clear Data History Buffer, Command #101**

This command clears the Data History Buffer by loading 255 in all 111 RangeMSB locations (see section 6). A ‘255’ is an indicator that the data record has been cleared or not acquired. As a safety measure, a second ‘Are You Sure’ command from the host will be required to actually perform the clearing operation. See the sequence below to perform this clear operation.

*Host requests to clear the Data History Buffer*

<Destination ID>	<Sender ID>	<Message Length>	<Command>	<Checksum>
Sensor ID	Host ID	5	101	checksum
default=1	default=251			

‘Are You Sure’ Response from Sensor

*Sensor responds with the ‘Acknowledge’ command including the requesting command number*

<Destination ID>	<Sender ID>	<Message Length>	<Command>	<AcknowledgeToCommand>	<Checksum>
Host ID	Sensor ID	6	200	101	checksum
default=251	default=1		Acknowledge		

*The host then replies back to the Sensor with an ‘Acknowledge’ or ‘Cancel’ command shown below*

**Acknowledge command**

<Destination ID>	<Sender ID>	<Message Length>	<Command>	<ASCII ‘G’>	<Checksum>
Sensor ID	Host ID	6	101	71	checksum
default=1	default=251		Acknowledge	GO indicator	

*The command below can be used (or any other command) to quit the clearing function.*

**Cancel command**

<Destination ID>	<Sender ID>	<Message Length>	<Command>	<ASCII ‘Q’>	<Checksum>
Sensor ID	Host ID	6	101	81	checksum
default=1	default=251		Ack. To	Quit indicator	

*Sensor responds with the ‘Acknowledge’ to the GO command after it cleared the history buffer*

<Destination ID>	<Sender ID>	<Message Length>	<Command>	<AcknowledgeToCommand>	<Checksum>
Host ID	Sensor ID	6	200	101	checksum
default=251	default=1		Acknowledge		

**8.2.9.1 Host Command to SonAire M3: Reset Event Counter, Command #102**

This command clears the Event Counter register. Here is the format for this message.

<Destination ID>	<Sender ID>	<Message Length>	<Command>	<Checksum>
Sensor ID	Host ID	5	102	checksum
default=1	default=251			

**8.2.9.2 Response to “Reset Event Counter” Command #102**

In response to Command #102, the sensor returns the Acknowledge command after resetting the Event Counter. Here is the format of this message.

<Destination ID>	<Sender ID>	<Message Length>	<Command>	<AcknowledgeToCommand>	<Checksum>
Host ID	Sensor ID	6	200	102	checksum
default=251	default=1		Acknowledge		

**8.2.10.1 Host Command to SonAire M3: Reset Deep-Sleep Timer, Command #103**

This command resets the Deep-Sleep Timer used to maintain several sensors Deep-Sleep time in sync with one another. Here is the format for this message.

```
<Destination ID> <Sender ID> <Message Length> <Command> <Checksum>
Sensor ID      Host ID      5          103      checksum
default=1     default=251
```

**8.2.10.2 Response to “Reset Deep-Sleep Timer” Command #103**

In response to Command #103, the sensor returns the Acknowledge command after resetting the Deep-Sleep Timer. Here is the format of this message.

```
<Destination ID> <Sender ID> <Message Length> <Command> <AcknowledgeToCommand> <Checksum>
Host ID      Sensor ID      6          200      103      checksum
default=251  default=1      Acknowledge
```

**8.2.11.1 Host Command to SonAire M3: “Keep XBee Awake”, Command #104**

This command sets the XBee’s SLEEP pin to stay awake and also can extend the XBee watchdog period. This command must be used prior to initiating XBee Over-The-Air (OTA) programming by the application. Although not required, the command can be sent prior to other SonAire M3 commands when passing significant amount of data such as SonAire M3 Firmware upgrade or Waveform data retrieval.

The time to hold the sleep pin in the Awake state is located in the AwakeHoldTime byte. The 2 byte XBeeWdTime value extends the XBee watchdog period from the default value of 60 seconds. Here is the format for this message. Once the response byte is receive (see 8.2.11.2), XBee OTA programming can commence.

```
<Destination ID> <Sender ID> <Message Length> <Command> <AwakeHoldTime> <XBeeWdTimeL> <XBeeWdTimeH> <Checksum>
Sensor ID      Host ID      8          104      0, 1, 30 to 255sec      0, 1, 300 to 3600 sec      checksum
default=1     default=251
```

Time periods defined:

Awake Hold Time	Operation
0	Set to normal operation (LED will blink every 2 seconds). Default at power up and at re-boot.
1	Keep the XBee Awake indefinitely. Restore to normal operation by sending a reset command or command 104 with
AwakeHoldTime=0.	
30 to 255	Keep the XBee Awake from 30 to 255 seconds
XBee WD Time	Operation
0	Set to normal operation with factory default of XBee Watchdog period of 60 seconds. Default at power up and at re-boot.
1	XBee watchdog time disabled. Restore to normal operation by sending a reset command or command 104 with XBeeWdTime=0.
300 to 3600	XBee watchdog time from 300 seconds to 1800 seconds (5 minutes to 1 hour)

**8.2.11.2 Response to “Keep XBee Awake” Command #104**

In response to Command #104, the sensor returns the Acknowledge command after activating the XBee’s sleep pin. Here is the format of this message. Note that the application should then initiate programming the XBee radio.

```
<Destination ID> <Sender ID> <Message Length> <Command> <AcknowledgeToCommand> <Checksum>
Host ID      Sensor ID      6          200      104      checksum
default=251  default=1      Acknowledge
```

Reply message if AwakeHoldTime or XBeeWdTime outside limits

```
<Destination ID> <Sender ID> <Message Length> <Command> <AcknowledgeToCommand> <Error> <Checksum>
Host ID      Sensor ID      7          200      104      1      checksum
default=251  default=1      Acknowledge
```

*OTA Application Programming example #1 (with SonAire M3 Deep Sleep Timer=0):*

- 1) Send Command #104 with AwakeHoldTime=120 and XBeeWdTime=600 (2 minutes and 10 minutes respectfully)
- 2) Wait for acknowledge command #104
- 3) Start OTA programming. The OTA XBee programming typically takes 1 to 2 minutes.
- 4) When OTA programming complete, either send Command #104 with AwakeHoldTime=0 and XBeeWdTime=0, reboot sensor or ignore and wait for timeouts.

## MASSA PRODUCTS CORPORATION

OTA Application Programming example #2 (with SonAire M3 Deep Sleep Timer=0):

- 1) Send Command #104 with AwakeHoldTime=1 and XBeeWdTime=1
- 2) Wait for acknowledge command #104
- 3) Start OTA programming. The OTA XBee programming typically takes 1 to 2 minutes.
- 4) When OTA finished, send Command #104 with AwakeHoldTime=0 and XBeeWdTime=0 or reboot sensor.

### 8.2.12.1 Host Command to SonAire M3 and Response: Re-Boot (restart) Sensor, Command #199

This command reboots (restarts) the sensor. As a safety measure, a second command from the host is required to actually perform the reboot operation. See the sequence below.

*Host requests to reboot the Sensor*

<Destination ID>	<Sender ID>	<Message Length>	<Command>	<Checksum>
Sensor ID	Host ID	5	199	checksum
default=1	default=251			

'Are You Sure' Response from Sensor

*Sensor responds with the 'Acknowledge' command including the requesting command number*

<Destination ID>	<Sender ID>	<Message Length>	<Command>	<AcknowledgeToCommand>	<Checksum>
Host ID	Sensor ID	6	200	199	checksum
default=251	default=1		Acknowledge		

*The host then replies back to the Sensor with an 'Acknowledge' or 'Cancel' command shown below*

**Acknowledge command**

<Destination ID>	<Sender ID>	<Message Length>	<Command>	<ASCII 'G'>	<Checksum>
Sensor ID	Host ID	6	199	71	checksum
default=1	default=251		Acknowledge	GO indicator	

*The command below can be used (or any other command) to quit the clearing function. There will not be any response from the sensor to this command.*

**Cancel command**

<Destination ID>	<Sender ID>	<Message Length>	<Command>	<ASCII 'Q'>	<Checksum>
Sensor ID	Host ID	6	199	81	checksum
default=1	default=251		Ack. To	Quit indicator	

*Sensor responds with the 'Acknowledge' to the GO command after it cleared the history buffer*

<Destination ID>	<Sender ID>	<Message Length>	<Command>	<AcknowledgeToCommand>	<Checksum>
Host ID	Sensor ID	6	200	199	checksum
default=251	default=1		Acknowledge		

### 8.2.13 Sensor "Acknowledge" response to some Host requests, Command #200

Command #200 is an acknowledge message by the sensor to the host in response to a particular request that was received and accepted. See format below. The 5<sup>th</sup> byte in this message is the Command number in which this message is responding.

**6 byte acknowledge message**

<Destination ID>	<Sender ID>	<Message Length>	<Command>	<AcknowledgeToCommand>	<Checksum>
Host ID	Sensor ID	6	200	x	checksum
default=251	default=1		Acknowledge		

**7 byte acknowledge message**

<Destination ID>	<Sender ID>	<Message Length>	<Command>	<AcknowledgeToCommand>	<ValueError>	<Checksum>
Host ID	Sensor ID	7	200	x	0 = no error 1 = error	checksum
default=251	default=1		Acknowledge			

**8.2.14 Host Command to SonAire M3: Re-Send Message, Command #201**

Command #201 is a Resend request message to the sensor, whose requested data failed to be received properly or not at all by the host. It has a byte that indicates the active command, a block address and/or other data. See the format below.

<Destination ID> <Sender ID> <Message Length> <Command> <ReSendToCommand> <WaveformBlock#> <Checksum>  
 Sensor ID      Host ID              7                      201                      10                      1 to 28                  checksum  
 default=1      default=251                                      Re-Send

Host requests, such as ‘Write to Configuration Registers’, which fail to receive a response (Acknowledge) should use the same ‘Write’ command and not this Re-Send command.

**8.2.15 Sensor “Checksum Error”, Command #202**

If the sensor detects a checksum error, it will reply with Command 202. See the format below.

<Destination ID> <Sender ID> <Message Length> <Command> <Checksum>  
 Host ID      Sensor ID              5                      202                  checksum  
 default=251      default=1                                      Checksum Error

**8.2.16 Sensor response when no application firmware present “Bootloader Only”, Commands #247, #248 and #249**

If the sensor’s application firmware is not present, then only reprogramming “Bootloader” code is available. Commands sent to the sensor at this point other than specific reprogramming commands will be replied to with the “Bootloader Only” response command shown below. Reprogramming the sensor’s firmware will be done by Massa’s application software and is not outlined in this document. Note that the sensor’s Green LED will be active when in this mode.

<Destination ID> <Sender ID> <Message Length> <Command> <Checksum>  
 Host ID      Sensor ID              5                      249                  checksum                  (Bootloader ver 1 for sensor versions 23.x and earlier)  
 default=251      default=1                                      bootloader only

<Destination ID> <Sender ID> <Message Length> <Command> <Checksum>  
 Host ID      Sensor ID              5                      248                  checksum                  (Bootloader ver 2 for sensor versions 24.x to 27.x)  
 default=251      default=1                                      bootloader only

<Destination ID> <Sender ID> <Message Length> <Command> <Checksum>  
 Host ID      Sensor ID              5                      247                  checksum                  (Bootloader ver 3 for sensor versions 29.x and greater)  
 default=251      default=1                                      bootloader only

**8.2.17.1 Host Command to SonAire M3: Auto Discover of Sensors**

Massa’s python script loaded in the Digi Gateway ConnectPort™ gateway’s have the ability to perform a Node discovery function and will return detected MAC addresses from the sensors to the host. The format is to send the gateway an empty MAC address of 8 bytes of zeroes as shown below.

<MAC address>  
 8 byte address, all zeros (empty MAC address)

**8.2.17.2 Response to “Auto Discover of Sensors”**

The response from the gateway when an Auto Discover of Sensors (Node discover function) is requested is to return all the detected Sensor’s MAC addresses. There are no delimiters so the responses will always be in multiples of 8 bytes. The format is shown below. Note that it may take several seconds to receive this data while in the discovery process.

<MAC addressSensor1> <MAC addressSensor2> ··· <MAC addressSensorN>  
 8 byte sensor address      8 byte sensor address                  8 byte sensor address

## 9.0 Configuration Registers

The SonAire M3 Configuration Registers control the operation of the sensor. This section describes in detail the function of each register. Use the write and read commands to configure and validate each register location. If any register is outside the limits, then it will be replaced with the factory default and the Error Indicator byte 65 bit 0 will be set. Confirm the Error byte after changing a register.

### 9.1 Configuration Register Table

Register Name	Reg Addr	Register Limits	Note
Data Collection Interval	1-3	0 - 16777215	default = 3600 (once an hour), resolution 1 second units
Deep-Sleep Timer	4-5	0 & 6 – 43200 65000 (FW 32.xx)	default = 0 (timer disabled), 2.048 second units
Awake Timer	6-7	6-293	default = 12 (24 seconds), 2.048 second units
Outgoing Message Mode (active when Deep-Sleep Timer non-zero)	8	0 – 6	Default = 0 (off), 1=AutoSend1, 2=AutoSend2, 3=AutoSend3, 4=Acknowledge, 5=AutoSend5, 6= AutoSend6
Zigbee / Unassociated state	9	0 & 4 - 254	default = 0, consecutive Awake periods to reboot if unassoc
User Description Field	32-63	32-126	default = 32 ASCII spaces
Error Indicator	65	see section 9.2.9	Note: bit 0 must be cleared to write to any register
Extended Blanking Distance 1	66	0-254	default = 0 (FW control), 0.25" units added to pings < 10 cycles
Extended Blanking Distance 2	67	0-254	default = 0 (FW control), 0.25" units added to pings ≥ 10 cycles
Threshold Voltage #1	78	1 - 22	default = 8 (M3-150), 8 (M3-95) , 14 (M3-50)
Threshold Voltage #2	79	0 - 22	default = 6 (M3-150), 5 (M3-95) , 9 (M3-50)
Threshold Voltage #3	80	0 - 22	default = 4 (M3-150), 2 (M3-95) , 6 (M3-50)
Threshold Voltage #4	81	0 - 22	default = 2 (M3-150), 1 (M3-95) , 2 (M3-50)
Thresh. Switch Time #2	82-83	model dependent	default = 2400 (M3-150), 8000 (M3-95) , 12000 (M3-50)
Thresh. Switch Time #3	84-85	model dependent	default = 3200 (M3-150) , 12000 (M3-95) , 16000 (M3-50)
Thresh. Switch Time #4	86-87	model dependent	default = 4000 (M3-150) , 16000 (M3-95) , 20000 (M3-50)
Outgoing Message Mode # Data Records	101	1-8	default = 8. Available for FW versions 26 or greater.
Ultrasonic Waveform Cycles	109	1 - 20	default = 10
Ultrasonic Waveform Gain	110	0 or 1	Default = 1 (hi gain)
Ultrasonic Waveform Temperature	111		Temperature stored here at the time of ultrasonic waveform
Serial Number	115-118		Read Only

#### 9.1.1 Configuration Register Table For Custom Sensitivity Low Power (typically customized when mounted in standpipe)

These settings apply to model 150 (FW 32.23), 95 (FW 32.10), 50 (FW 32.6) or greater. See SonAire M3 System Integrators Guide for additional details for setting values when SonAire M3 installed in standpipes.

Register Name	Reg Addr	Register Limits	Note
Short Ping Custom Thresholds	10	0, 1	default =0 (disable), 1=enable registers 11-30
Threshold Voltage #1 (USP)	11	1 - 22	default=19 M3-50 only (4-cycle ping)
Threshold Voltage #2 (USP)	12	0 - 22	default=7 M3-50 only (4-cycle ping)
Threshold Voltage #3 (USP)	13	0 - 22	default=2 M3-50 only (4-cycle ping)
Threshold Voltage #4 (USP)	14	0 - 22	default=0 M3-50 only (4-cycle ping)
Thresh. Switch Time #2 (USP)	15-16	785-54557	default=1000 M3-50 only (4-cycle ping)
Thresh. Switch Time #3 (USP)	17-18	785-54557	default=1250 M3-50 only (4-cycle ping)
Thresh. Switch Time #4 (USP)	19-20	785-54557	default=1500 M3-50 only (4-cycle ping)
Threshold Voltage #1 (SP)	21	1 - 22	default = 20 (M3-150),14 (M3-95) , 19 (M3-50)
Threshold Voltage #2 (SP)	22	0 - 22	default =10 (M3-150),10 (M3-95) ,7 (M3-50)
Threshold Voltage #3 (SP)	23	0 - 22	default =1 (M3-150),1 (M3-95) ,2 (M3-50)
Threshold Voltage #4 (SP)	24	0 - 22	default =0 (M3-150),0 (M3-95) ,0 (M3-50)
Thresh. Switch Time #2 (SP)	25-26	1093-49600 (/150 & 95), 785-54557 (/50)	default =300 (M3-150),800 (M3-95),1250 (M3-50)
Thresh. Switch Time #3 (SP)	27-28	1093-49600 (/150 & 95), 785-54557 (/50)	default =600 (M3-150),1600 (M3-95),1500 (M3-50)
Thresh. Switch Time #4 (SP)	29-30	1093-49600 (/150 & 95), 785-54557 (/50)	default =900 (M3-150),2400 (M3-95),1750 (M3-50)

## 9.2 Sensor Configuration Register Description

### 9.2.1 Data Collection Interval Register (addr = 1-3)

The *Data Collection Interval* register controls the wake up period to acquire all pertinent sensor data and save it to the Sensor's Data History Buffer. The resolution for this 3-byte register is 1 bit per second with the LSB at location 1 and the MSB at location 3. A zero in this register will represent the *Manual* acquisition mode and will require Command #2 or Command #3 by the Host device to perform a new acquisition of data. Minimum acquisition time is once every 10 seconds and a maximum of once every 194 days.

### 9.2.2 Deep-Sleep Timer Register (addr = 4-5)

The *Deep-Sleep Timer* register contains the time value which places the XBee radio in a low power sleep mode to increase battery life of the sensor. The resolution for this 2-byte register is 2.048 seconds with the LSB at location 4 and the MSB at location 5. After this timer expires, the XBee radio will turn on for the period indicated in the "Awake Timer" register (see below). The Deep-Sleep Timer will wake up the sensor at its programmed rate and is independent of the Awake Timer. If the Awake Timer is programmed to be longer than the Deep-Sleep Timer, a fault will be indicated in the Status1 byte message and bit 0 will be set in the Error Indicator Register (section 9.2.9). On error, both of these timer registers will be replaced with the default values (see Section 9.1). A zero in this register will disable the Deep-Sleep operation and the radio will wake up every 2 seconds (Awake Timer register is ignored). However, if the sensor is not associated with a gateway, it will default to 1 minute sleep periods when this register is zero. The sensor will not respond to any commands when it is sleeping.

### 9.2.3 Awake Timer Register (addr = 6-7)

The *Awake Timer* register contains the time value the XBee radio will remain awake after the Deep-Sleep timer has expired. Minimum time for this register is 6 (12 seconds). Incoming messages to the sensor will reset this timer extending this awake period and allows long messaging such as waveform retrieval to be passed before the sensor goes back to sleep. The resolution for this 2-byte register is 2 seconds with the LSB at location 6 and the MSB at location 7. This function will be ignored if the Deep-Sleep Timer is set to zero and the sensor will operate in the Manual mode as described below. If the Awake Timer is programmed to be longer than the Deep-Sleep Timer, a fault will be indicated in the Status1 byte message and bit 0 will be set in the Error Indicator Register (section 9.2.9). On error, both of the Deep-Sleep and Wake Up timer registers will be replaced with the default values (see Section 9.1).

### 9.2.4 Extended Blanking Distance 1 Register (addr = 66)

The *Extended Blanking Distance 1* register contains the value for adding additional blanking distance after the sensor has pinged in cases where obstructions or slower speed of sound due to vapor is present. This setting applies to sensor transmit pulses < 10 cycles and is added to the factory minimum values. Default value of 0 sets the minimum sensor blanking time set by factory values. Register is defined as 0.25" units and is available for firmware versions model SonAire M3/150 32.24 or greater, model SonAire M3/95 32.11 or greater, model SonAire M3/50 32.7 or greater.

### 9.2.5 Extended Blanking Distance 2 Register (addr = 67)

The *Extended Blanking Distance 2* register contains the value for adding additional blanking distance after the sensor has pinged in cases where obstructions or slower speed of sound due to vapor is present. This setting applies to sensor transmit pulses  $\geq 10$  cycles and is added to the factory minimum values. Default value of 0 sets the minimum sensor blanking time set by factory values. Register is defined as 0.25" units and is available for firmware versions model SonAire M3/150 xx.24 or greater, model SonAire M3/95 xx.11 or greater, model SonAire M3/50 32.7 or greater.

**9.2.6 Outgoing Message Mode Register (addr = 8)**

The *Outgoing Message Mode* register contains the value on the method the sensor will send Outgoing Messages when it wakes up from Deep-Sleep. The table below indicates the operating mode based on this register value. This function will be active when the Deep-Sleep register (4-5) is non-zero. If the application expects the gateway to drop the sensor from its device table, it is recommended Auto Send 2 messaging be used with a minimum value for the Awake Timer set to 12 (24 seconds). The gateway may not receive the 1<sup>st</sup> sensor message as it is attempting to associate itself with the gateway, but the 2<sup>nd</sup> copy should be received. See section 8.2.1.2 for the outgoing message format. See section 9.2.12 for limiting the # of Event Blocks within the message.

Reg Value	Message Mode	Operation after waking up from Deep-Sleep
0	Manual	Sensor will only send messages upon request during the Awake period (default setting).
1	Auto Send 1	Sensor will send a single Command 1 message containing up to 8 blocks of recorded Event Data and will wait for the entire programmed Awake Time for any normal protocol requests. There is no demand for any acknowledgement and no retry will be sent.
2	Auto Send 2	Sensor will send a single Command 1 message containing up to 8 blocks of recorded Event Data and will wait for ½ the programmed Awake Time then sensor will send a second copy. Awake Time will continue in its entirety for any normal protocol requests. There is no demand for any acknowledgement and no retry will be sent.
3	Auto Send 3	Sensor will send a single Command 1 message containing up to 8 blocks of recorded Event Data and will wait for ½ the programmed Awake Time for a protocol acknowledgement (Command 200). If acknowledge message is not received within ½ of Wake up Time, then a second copy will be sent. Awake Time will continue in its entirety for any normal protocol requests.
4	Acknowledge	Sensor will send a single Acknowledge message indicating that it is awake. <b>Coordinator</b> now can send messages during the awake period.
5	Auto Send 5	Sensor will first acquire range and other status information followed by sending a single Command 1 message containing up to 8 blocks of recorded Event Data. The Awake Time will continue in its entirety for any normal protocol requests. There is no demand for any acknowledgement and no retry will be sent. The Data Collection Interval Register is disabled. (FW ver 26 or greater)
6	Auto Send 6	Sensor will first acquire range and other status information followed by sending a single Command 1 message containing up to 8 blocks of recorded Event Data. Sensor will wait for ½ the programmed Awake Time then send a second copy. The Awake Time will continue in its entirety for any normal protocol requests. There is no demand for any acknowledgement and no retry will be sent. The Data Collection Interval Register is disabled. (FW ver 26 or greater)

This is the Acknowledge Message sent by Coordinator after it has received Event Data and Configuration Register 8 set to 3.

```
<Destination ID> <Sender ID> <Message Length> <Command> <AcknowledgeToCommand> <Checksum>
Sensor ID      Host ID          6           200           1           checksum
default=1     default=251     Acknowledge read history buffer
```

This is the Acknowledge Message sent by Sensor after sensor wakes up and Configuration Register 8 set to 4.

```
<Destination ID> <Sender ID> <Message Length> <Command> <AcknowledgeToCommand> <Checksum>
Host ID       Sensor ID       6           200           0           checksum
default=251   default=1       Acknowledge
```

### 9.2.7 Zigbee / Unassociated State Register (addr = 9) (versions 31.x or greater)

The *Zigbee / Unassociated State* register is used to reboot the sensor if a fault condition has occurred either by Zigbee messages that are not being acknowledged (by gateway) or if sensor is unassociated with gateway for some other reason. A counter will increment a fault once every Awake period or it will be cleared if message was acknowledged as delivered. If consecutive faults occur up to the programmed *Zigbee / Unassociated State* register value, then the sensor will reboot. This can also be regarded as a Zigbee watchdog register. Register limits are 0 or 4 – 254 with 0 disabling this feature. Suggested setting for this register is for a reboot rate every 24 hours. Timing is based on Deep Sleep register, i.e., Deep Sleep = 1 hour, set Zigbee/Unassociated State register = 24.

### 9.2.8 User Description Field Register (addr = 32-63)

The *User Description Field* registers is for the user to store descriptive information. Only one byte ASCII characters (values from 32 through 126) will be accepted in these 32 registers.

### 9.2.9 Error Indicator Register (addr = 65)

The *Error Indicator* register will identify multiple sensor faults with 0 representing that the sensor is OK. Status Byte 1, bit 7 in the Event Data will be set if any bit is set within this Error Indicator register. Below are the fault codes for each bit. Errors are cleared by sending a zero to this register. If Bit 0 = 1, then this would indicate the sensor had replaced at least one configuration register to factory default value after it was detected being out of range. Note: Sensor registers cannot be written to until this bit has been cleared.

- Bit 0: Configuration Register value replaced (configuration register out of range, replaced with factory default)
- Bit 1: Sensor Detection Fault. Perform Ultrasonic Waveform to verify sensor signals. Consult factory.
- Bit 2: Temperature Probe Fault. Consult factory.
- Bit 3: Brown Out Fault. Power supply low.
- Bit 4: Power Supply Low. Replace batteries

### 9.2.10 Sensor Threshold Voltage Adjustment Registers (addr = 78-81)

The *Sensor Threshold Voltage Adjustment* registers allows the user to adjust sensitivity of the sensor's capturing circuitry. The settings shown in the table below are used for the long transmit cycle (10 or more cycles) by the sensor to acquire targets further away which were not detected by the sensor's initial attempt to acquire targets up close (with 1 cycle transmission). The table in section 9.1 shows the recommended default values. In application software, the Ultrasonic Waveform and these thresholds can be superimposed so that the sensor's sensitivity adjustments can be tailored for the application. Note that there will be pre-programmed settings named 'Very-High', 'Hi', 'Normal-Hi', 'Normal' (default), 'Low', and 'Very-Low' for these Long Cycle transmit registers. This will be selected by application software and the selection will be indicated in Status Byte 2 bits 5-7 (see section 6.1). The threshold index values are listed below. **Voltage Thresholds - 0:** No switching to occur **1:** 0.75V, **2:** 0.84V, **3:** 0.88V, **4:** 0.94V, **5:** 1.00V, **6:** 1.03V, **7:** 1.13V, **8:** 1.22V, **9:** 1.25V, **10:** 1.31V, **11:** 1.38V, **12:** 1.41V, **13:** 1.50V, **14:** 1.59V, **15:** 1.63V, **16:** 1.69V, **17:** 1.75V, **18:** 1.78V, **19:** 1.88V, **20:** 1.97V, **21:** 2.06V, **22:** 2.16V

### 9.2.11 Sensor Threshold Time Adjustment Registers (addr = 82-87)

The *Sensor Threshold Time Adjustment* registers allows the user to adjust the time when the sensor's capturing circuitry threshold voltage is to change. The Threshold Switch Time units are 500nS/bit (2uS/bit for SonAire M3/50) with the LSB in the lower address and the MSB in the higher address. If a "Zero" is stored for a Threshold Voltage, then no voltage change will occur and the previous voltage threshold will remain in effect. Typically the voltage is set higher at the beginning and lowered as time passes.

### 9.2.12 Outgoing Message Mode # Data Records Register (addr = 101)

The *Outgoing Message Mode # Data Records* register is used to set the number of Event Data records that will be automatically sent when sensor is programmed to send upon awake from deep sleep. See section 8.2.1.2 for the outgoing message format. This register is limited to 1-8 records and is defaulted to 8.

### 9.2.13 Ultrasonic Waveform Cycles Register (addr = 109)

The *Ultrasonic Waveform Cycles* register selects the number of transmit cycles for the Ultrasonic Waveform routine. Limits are from 1 to 20 cycles. Typical transmit cycles for the sensor's operation is 1, 10, or 20 dependent on acquisition of an echo.

### 9.2.14 Ultrasonic Waveform Gain Register (addr = 110)

The *Ultrasonic Waveform Gain* register is used to independently control the gain for the Ultrasonic Waveform routine. Programmed for 0 will set the gain to Low, and programming it to 1 will set the gain to High. Set this to High for most applications.

**9.2.15 Ultrasonic Waveform Temperature Register (addr = 111)**

The *Ultrasonic Waveform Temperature* register is updated every time the Ultrasonic Waveform is acquired. This register is included in with the rest of the header bytes of the ultrasonic waveform.

**9.2.16 Serial Number Register (addr = 115-118)**

This register contains the sensor’s 4 byte serial number and is a read only register. Register 118 is the most significant byte.

**9.2.17 Short Ping Custom Threshold Enable (addr = 10) (FW 32.xx or greater)**

The *Short Ping Custom Threshold Enable* register enables use of custom sensitivity threshold registers 11-30 used in sensor’s low power ping. Select ‘0’ for factory defaults or ‘1’ to enable registers 11-30. Typically set to ‘0’ in direct flange mount and ‘1’ when mounted in standpipes. See SonAire M3 System Integrators Guide for additional details for setting values when SonAire M3 installed in standpipes.

**9.2.18 Ultra Short Ping Custom Threshold Voltage Adjustment Registers (addr = 11-14) (SonAire M3/50 FW 32.6 or greater)**

The *Ultra Short Ping Custom Threshold Voltage Adjustment* registers allows the user to adjust sensitivity of the sensor’s capturing circuitry for the SonAire M3/50 Sensor low power mode typically for close targets. See SonAire M3 System Integrators Guide for additional details for setting values when SonAire M3 installed in standpipes. The threshold index values are listed below.

**Voltage Thresholds - 0:** No switching to occur **1:** 0.75V, **2:** 0.84V, **3:** 0.88V, **4:** 0.94V, **5:** 1.00V, **6:** 1.03V, **7:** 1.13V, **8:** 1.22V, **9:** 1.25V, **10:** 1.31V, **11:** 1.38V, **12:** 1.41V, **13:** 1.50V, **14:** 1.59V, **15:** 1.63V, **16:** 1.69V, **17:** 1.75V, **18:** 1.78V, **19:** 1.88V, **20:** 1.97V, **21:** 2.06V, **22:** 2.16V

**9.2.19 Ultra Short Ping Custom Threshold Time Adjustment Registers (addr = 15-20) (SonAire M3/50 FW 32.6 or greater)**

The *Ultra Short Ping Custom Threshold Time Adjustment* registers allows the user to adjust the time when the sensor’s capturing circuitry threshold voltage is to change. The switch time units are 2uS/bit for SonAire M3/50 with the LSB in the lower address and the MSB in the higher address. If a “Zero” is stored for a Threshold Voltage, then no voltage change will occur and the previous voltage threshold will remain in effect. Typically the voltage is set higher at the beginning and lowered as time passes. See SonAire M3 System Integrators Guide for additional details for setting values when SonAire M3 installed in standpipes.

Ultra Short Ping Custom Threshold Settings

Time	Registers		Threshold	Registers
Start		<i>initial threshold</i>	Ultra Short Thresh Voltage #1	11
Ultra Short Threshold Switch Time 2	15-16	<i>will switch threshold to</i>	Ultra Short Thresh Voltage #2	12
Ultra Short Threshold Switch Time 3	17-18	<i>will switch threshold to</i>	Ultra Short Thresh Voltage #3	13
Ultra Short Threshold Switch Time 4	19-20	<i>will switch threshold to</i>	Ultra Short Thresh Voltage #4	14

**9.2.20 Short Ping Custom Threshold Voltage Adjustment Registers (addr = 11-14) (FW 32.xx or greater)**

The *Short Ping Custom Threshold Voltage Adjustment* registers allows the user to adjust sensitivity of the sensor’s capturing circuitry for the SonAire M3/50 Sensor low power mode typically for close targets. See SonAire M3 System Integrators Guide for additional details for setting values when SonAire M3 installed in standpipes. The threshold index values are listed below.

**Voltage Thresholds - 0:** No switching to occur **1:** 0.75V, **2:** 0.84V, **3:** 0.88V, **4:** 0.94V, **5:** 1.00V, **6:** 1.03V, **7:** 1.13V, **8:** 1.22V, **9:** 1.25V, **10:** 1.31V, **11:** 1.38V, **12:** 1.41V, **13:** 1.50V, **14:** 1.59V, **15:** 1.63V, **16:** 1.69V, **17:** 1.75V, **18:** 1.78V, **19:** 1.88V, **20:** 1.97V, **21:** 2.06V, **22:** 2.16V

**9.2.21 Short Ping Custom Threshold Time Adjustment Registers (addr = 15-20) (FW 32.xx or greater)**

The *Short Ping Custom Threshold Time Adjustment* registers allows the user to adjust the time when the sensor’s capturing circuitry threshold voltage is to change. The switch time units are 500nS/bit (2uS/bit for SonAire M3/50) with the LSB in the lower address and the MSB in the higher address. If a “Zero” is stored for a Threshold Voltage, then no voltage change will occur and the previous voltage threshold will remain in effect. Typically the voltage is set higher at the beginning and lowered as time passes. See SonAire M3 System Integrators Guide for additional details for setting values when SonAire M3 installed in standpipes.

Short Ping Custom Threshold Settings

Time	Registers		Threshold	Registers
Start		<i>initial threshold</i>	Short Thresh Voltage #1	21
Short Threshold Switch Time 2	25-26	<i>will switch threshold to</i>	Short Thresh Voltage #2	22
Short Threshold Switch Time 3	27-28	<i>will switch threshold to</i>	Short Thresh Voltage #3	23
Short Threshold Switch Time 4	29-30	<i>will switch threshold to</i>	Short Thresh Voltage #4	24

### 10.0 Digi's ConnectPort™ X2 & X4 Gateways and Python Script

*NOTE: Communicating with the Digi X4 Gateway using its comm port is no longer the preferred method. Please see the System Integrator's Guide which utilizes the gateway's Ethernet port and Massa's Python Driver's to communicate with the SonAire M3 Sensor. The SonAire M3 Software can be used to view recorded waveforms which also contain past records and sensor settings.*

#### 10.1 Description

Communicating with the SonAire M3 Sensor will require a Digi ConnectPort™ X2 or ConnectPort™ X4 Gateway. The SonAire M3 Application Software will provide the user with an evaluation tool accessing all of the sensor's features. Since the X2 model does not have a serial port, it cannot be used with the SonAire M3 Application Software. To use this software will require a python program specifically written for a serial port communications between the gateway and PC. File name for this python code is "massa\_gateway\_appl.py" and can be found at [www.massa.com](http://www.massa.com). See section 12 for setting up the gateway with this python code. For custom python application programs, consult Massa Products for more information.

### 11.0 Reprogramming Sensor's Firmware

#### 11.1 Description

Massa SonAire M3 Software will allow upgrading the sensor's firmware. An alternate method is to use Massa Python to upgrade the sensor's firmware, see SonAire M3 Sensor System Integrators Guide. See [www.massa.com](http://www.massa.com) for the most up to date firmware. The latest software will also contain the latest firmware release.

### 12.0 Getting Started Guide

Using the SonAire M3 Application Software should be your first step in evaluating your ultrasonic level sensing application. The wireless connection bridge between your PC and the SonAire M3 Sensor is the Digi ConnectPort X4, X8 or iDigi Gateway. The gateway must be set up for use with the SonAire M3 application software which includes loading python code from Massa's web site, adjusting gateway poll timeout settings, and setting up the gateway's serial port. Setting up the gateway is done through the Ethernet connection while the SonAire M3 Software communicates through the PC's serial port. Once the gateway is set up, you will no longer need the Ethernet connection. Here are the steps necessary to successfully start evaluate the SonAire M3 Sensor using the SonAire M3 Application Software. The screens shown below are all from ZB series radios.

- 1) Purchase either a ZB ConnectPort X2 or X4 gateway from Digi International Inc. There are several models to choice including XBee to Ethernet or XBee to Ethernet and cellular. If using this iDigi Platform, refer to Massa's SonAire M3 and Digi Gateway User's Guide for additional information.
- 2) SonAire M3 Sensor which contains a ZB radio firmware.
- 3) Other required items include:
  - a. A personal computer with Ethernet port and serial comm. port.
  - b. If serial comm. port is not available on the PC, then select a USB port. Using a USB port will require a USB/RS232 converter that can be purchased at <http://www.massa.com>.
  - c. Serial null modem cable, 9 pin female/female p/n AE9879-ND at <http://www.digikey.com>
  - d. Ethernet cable (preferred method of communicating with sensor)

- Attach the serial null modem cable from the gateway to the PC. If your PC does not have a Comm Port, then you will have to obtain a USB/RS232 Converter. Follow the manufacturer's instructions on setting this up. Next, attach the Ethernet cable between the PC and gateway. Connect the Zigbee antenna to the gateway. Power the gateway with provided power supply. Obtain Digi's Device Discovery Software ([www.digi.com](http://www.digi.com)) used to find the gateway. Once it is found, double click on the IP address (see below) and the Digi Home page will be displayed as seen here on the right.

IP Address	MAC Address	Name	Device
192.168.1.149	00:40:9D:36:DF:53	ConnectPort X4	

**ConnectPort X4 Configuration and Management**

Home

Configuration  
 Network  
 Mobile  
 XBee Network  
 Serial Ports  
 Camera  
 Alarms  
 System  
 Remote Management  
 Security  
 Position

Applications  
 Python  
 RealPort  
 Industrial Automation

Management  
 Serial Ports  
 Connections  
 Event Loggers

**Home**

Getting Started

**Tutorial** Not sure what to do next? This Tutorial can help.

**System Summary**

Model: ConnectPort X4  
 Ethernet MAC Address: 00:40:9D:36:DF:53  
 Ethernet IP Address: 192.168.1.1  
 Mobile IP Address: Not Connected

Description: None  
 Contact: None  
 Location: None

Device ID: 00000000-00000000-00409DFF-FF36DF53

- Enter the XBee Configuration screen by clicking on **Configuration XBee Network**. Click on either the coordinator's *Network Address* [0000] or *Extended Address* [00:... ] and then scroll down and click on the **Advanced Settings** menu.

**ConnectPort X4 Configuration and Management**

Home

Configuration  
 Network  
 Mobile  
 XBee Network  
 Serial Ports  
 Camera  
 Alarms  
 System  
 Remote Management  
 Security

**XBee Configuration**

Network View of the XBee Devices

Node ID	Network Address	Extended Address	Node Type	Product Type
	[0000]	00:13:a2:00:40:30:64:09	coordinator	X4 Gateway

Clear list before performing refresh

Refresh

- In the Advanced Settings XBee Configuration menu, change the *Peripheral sleep count (SN)* register to **2880** and *Cyclic Sleep Period (SP)* register to **1000** and click *Apply*. This will set the gateway's poll timeout for 24 hours.

*NOTE: The poll timeout is calculated as 3 \* SN \* SP \* 0.01 seconds.*

Link encryption key (KY):  (0-16 bytes)

Maximum hops (NH):  (0-255)

Network encryption key (NK):  (0-16 bytes)

Node identifier (NI):  (0-20 chars)

Power mode (PM):  (0-1)

Scan channels (SC):  bitfield (0x1-0xffff)

Scan duration (SD):  exponent (0-7)

Peripheral sleep count (SN):  (1-65535)

Cyclic sleep period (SP):  x 10 msec (32-2800)

ZigBee stack profile (ZS):  (0-2)

Apply Cancel

- Click on the **Configuration Serial Ports** menu and then click on **Port 1**.

Home

Configuration  
 Network  
 Mobile  
 XBee Network  
 Serial Ports

**Serial Port Configuration**

Port	Description	Profile	Serial Configuration
Port 1	None	Custom	9600 8N1

- 8) Click on [Change Profile...](#)  
 NOTE: Make sure under Serial Services that *Access to the command line interface* is unchecked to reserve the port for the SonAire M3 Software.

This screenshot shows the 'Serial Port Configuration' window with the 'Port Profile Settings' section expanded. The 'Current Port Profile' is set to 'Custom'. Under 'Serial Services', the checkbox for 'Access the command line interface' is unchecked. The 'Custom' profile is selected, and a 'More...' link is visible. 'Apply' and 'Cancel' buttons are at the bottom.

- 9) In the *Select Port Profile...* menu, scroll down to the bottom, and select *Custom* and click the *Apply* button.

This screenshot shows the 'Serial Port Configuration' window with the 'Basic Serial Settings' section expanded. The 'Description' field is empty. The 'Baud Rate' is set to 9600, 'Data Bits' to 8, 'Parity' to None, 'Stop Bits' to 1, and 'Flow Control' to None. An 'Apply' button is visible below the settings.

- 10) While still in the Serial Port Configuration menu, click [Basic Serial Settings](#). Update the settings to Baud Rate=9600, Data Bits=8, Parity=None, Stop Bits=1, and Flow Control=None. Click the *Apply* button.

This screenshot shows the 'Python Configuration' window with the 'Python Files' section expanded. It shows a table of files:

Action	File Name	Size
<input type="checkbox"/>	python.zip	144321 bytes
<input type="checkbox"/>	zigbee.py	1147 bytes

The 'Delete' button is visible below the table. The 'Auto-start Settings' section is partially visible at the bottom.

- 11) The next step is to load the Massa Python code into the gateway. Obtain the python code `massa_gateway_appl.py` from <http://www.massa.com> and save it. Click on the **Applications Python** menu, browse to locate the python file, and then click on the Upload button to have it placed in the gateway's Manage Files server.

NOTE: The Manage Files must also contain both the python.zip and zigbee.py files. Download them off the Digi web site if not present.

This screenshot shows the 'Python Configuration' window with the 'Auto-start Settings' section expanded. It allows specifying python programs to be run when the device boots. The 'Enable' checkbox is checked, and 'massa\_gateway\_appl.py' is entered in the 'Auto-start command line' field. 'Apply' and 'Cancel' buttons are at the bottom.

- 12) The Massa Python code must be enabled when the gateway powers up. In the Python Configuration menu, click the [Auto-start Settings](#) menu and type `massa_gateway_appl.py` in the *Auto-start command line*. Check the *Enable* box and then click the *Apply* button. If there are any other python programs in this [Auto-start Settings](#) menu, make sure they are disabled.

- 13) Reboot the gateway to have the settings take affect by selecting **Administration Reboot**, then click on the Reboot button. This will take approximately 1 minute.

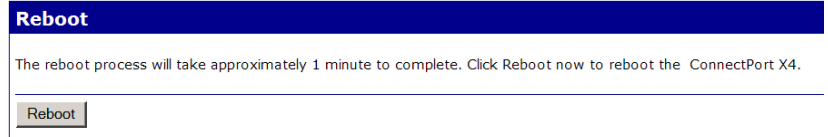

- 14) Verify if the Python code is active by entering the **Management Connections** menu. If the python code `Python:massa_gateway_appl.py` does not appear under the title **Protocol**, then you may have to reboot again or check to see if is it enabled in the **Auto-start Settings** menu as seen on Step 12.

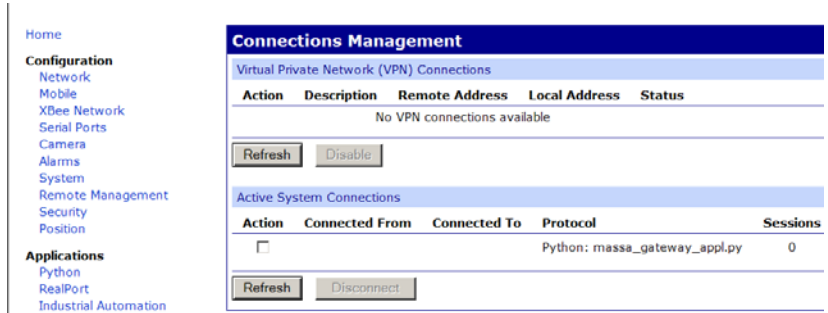

- 15) Turn on the SonAire M3 Sensor and wait for it to associate itself to the gateway (brief flash every 2 seconds). If it does not associate, press the sensor’s Commission button once. Click on the **Configuration XBee Network** menu and press the Refresh button to see the sensor on the device list. Once you have established the sensor on the ZigBee network, you can proceed to installing the SonAire M3 Application Software, see next page. Note that the Node ID will indicate sensor model type (from the XBee’s NI register).

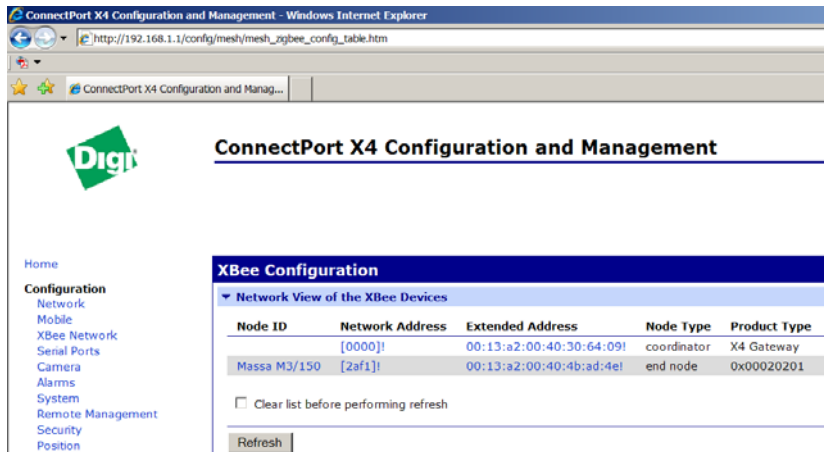

## 13.0 SonAire M3 Application Software

*NOTE: Communicating with the Digi X4 Gateway using its comm port is no longer the preferred method. Please see the System Integrator's Guide which utilizes the gateway's Ethernet port and Massa's Python Driver's to communicate with the SonAire M3 Sensor. The SonAire M3 Software can be used to view recorded waveforms which also contain past records and sensor settings.*

### 13.1 Introduction

The SonAire M3 Application Software allows access to the SonAire M3 Sensor to change settings, obtain the Data History Buffer from previously acquired data, request for range and status on demand, obtain an ultrasonic waveform for diagnostic or record keeping purposes, or upgrade new sensor firmware. This software gains access using the PC's comm. port while setting up the gateway was done through the PC's Ethernet connection accessing Digi's web pages. It is important to note that the SonAire M3 Application Software is strictly used for evaluation purposes to gain access to the sensor's features. Ultimately, the user will require custom gateway Python code and software for their specific application. Consult Massa Products for turnkey solution partners.

### 13.2 Set up

The Digi ConnectPort™ Gateway should be installed at this point. Obtain a copy of the SonAire M3 Application Software from <http://www.massa.com>. Download the zip file, extract the files, and execute setup.exe. The following section details the menus that allow you to gain access to the sensor. Power up the gateway and wait approximately 1 minute for it to boot. Note that a gateway and sensor are both defaulted to PAN ID = 0 from the factory for ZB series and PAN ID 234 for ZNET 2.5 series radios. This will allow the sensors to join the gateway out of the box.

### 13.3 Program Settings Menu

This menu can be accessed by the drop down menu item *View* then *Program Settings*. It will allow you to change the comm. port the gateway is connected to, adjust the Discovery timeout (recommended 10 seconds min.), enable or disable the search for sensors when the program starts, and to allow the Deep Sleep Timer to be disabled when the sensor is found by the gateway. Note1: that using a USB/RS232 Converter will most likely require the comm. port to be changed (from COM1). Note2: Checking the *Disable Deep Sleep when a Sensor is Found* box may be necessary if the Awake timer is programmed for a short period. This will prevent the sensor from going back to sleep so you can gain access to it.

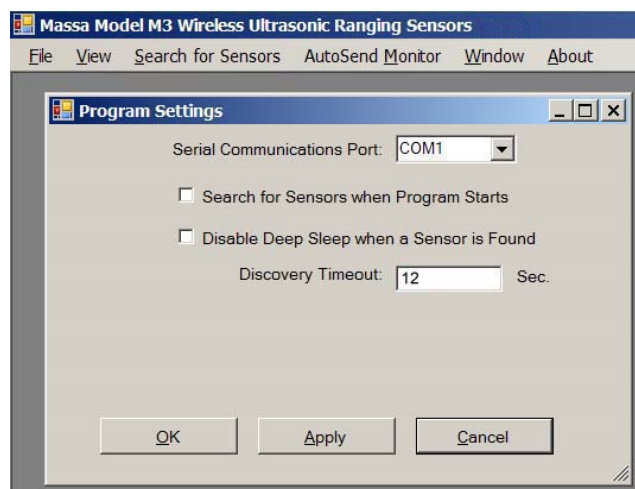

### 13.4 Search for Sensors Menu

Click on the *Search for Sensors* menu button to request for searching for sensors manually if it did not automatically do so when the application started. Make sure you have the sensor associated with the gateway (Sensor's LED brief flash every 2 seconds) for it to be found.

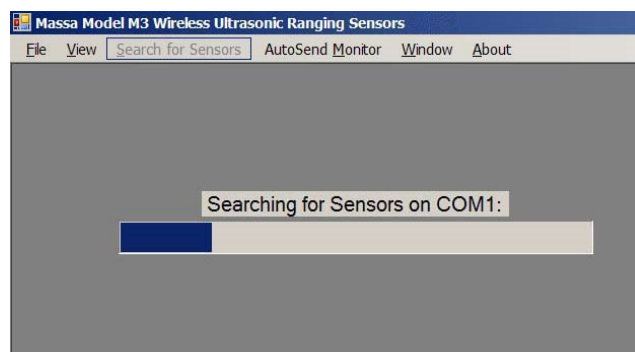

13.5 Sensor List

After the SonAire M3 Software has completed searching for sensors, a Sensor List menu will be displayed as show here. A sensor that can be accessed will be indicated in the *Avail* box. If not available but still in the gateway’s device list, then the sensor is either asleep, powered off, or out of range. You can search for sensors again when the sensor wakes up.

To view the sensor information details, click the *Shown* box and the menus listed below will be available.

A sensor that became not available will appear as show. This represents a situation where gateway has maintained the sensor in it child table (poll timeout has not expired) and the sensor may be asleep or out of range.

If the list is empty with the sensor associated to the gateway (Red LED blinks every 2 seconds), verify that the gateway’s Zigbee ACT LED blinks when you click Search for Sensors. If the Zigbee LED does not blink, re-power the gateway and wait for at least a minute for it to boot. The sensor will go to sleep when the gateway is booting. Wait another minute for the sensor to wake up or you may re-boot the sensor by removing battery, press the sensor’s Commission pushbutton, and then replace the battery. Note that with the sensor’s Deep Sleep timer is set to the factory default of zero, the sensor will sleep for 1 minute intervals if not associated with the gateway (to conserve battery power). When the sensor finally associates with the gateway, click *Search for Sensors*.

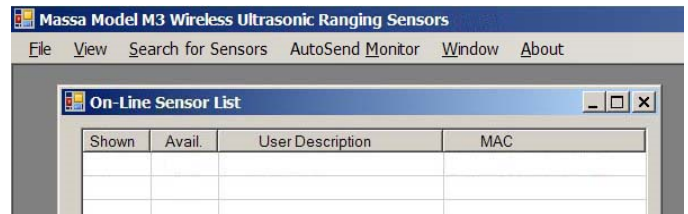
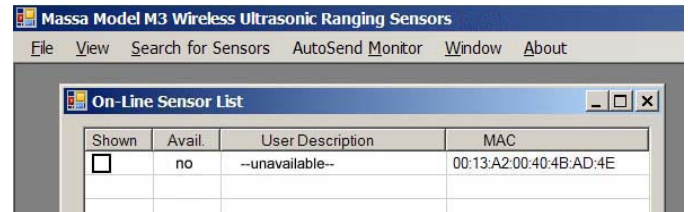
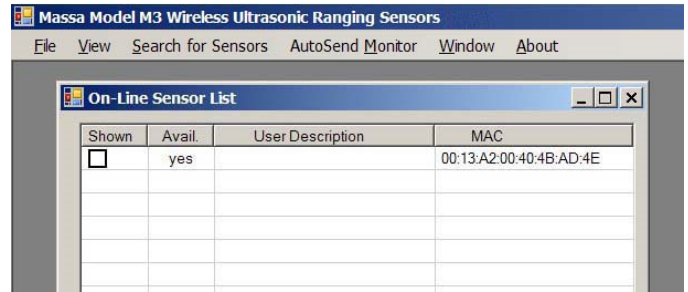

13.6 Sensor Settings Tab

The sensor Settings and Info tab will display the sensor’s ultrasonic operating settings. To edit them, click on the “Edit Settings” button and the menu on the right will appear. The following settings can be edited.

- a) *Sensor Description Field* can be used for uniquely identifying the sensor with up to 32 ASCII characters.
- b) *Data Collection Time Interval* register sets the rate at which the ultrasonic and associated data will be acquired automatically. Setting it to zero disables this feature. You can manually acquire data, see the **Data** tab menu.
- c) *Deep-Sleep Timer* register sets the sleep rate putting the sensor in a battery conserve mode by disabling the radio. Keep this register set to zero when evaluating this sensor to prevent it from going to sleep.
- d) *Awake Timer* register sets length of the time the radio is awake after it has woken up from its deep sleep period.
- e) *Outgoing Message Mode* register sets the operation for automatic sending of the range and status data when the radio wakes up from deep sleep.
- f) *Outgoing Message Records* register sets the amount of event records that are contained in a automated message. Default is 8.
- g) *Zigbee Failures Boot* register is a number of consecutive awake periods where communications could not be established with the gateway. If this limit is reached, the sensor will reboot which power cycles the XBee (in most cases reestablishing communications).
- h) *Errors* register stores the error codes when sensor has a fault. This can be cleared with the *Clear Error* button.
- i) *Sensitivity* is used to adjust the ultrasonic detection levels for acquiring targets. Custom settings can be programmed.

To change any settings, enter a valid value and hit the Apply or OK button. Scrolling over to the label will indicate the register limits in the text box to the right.

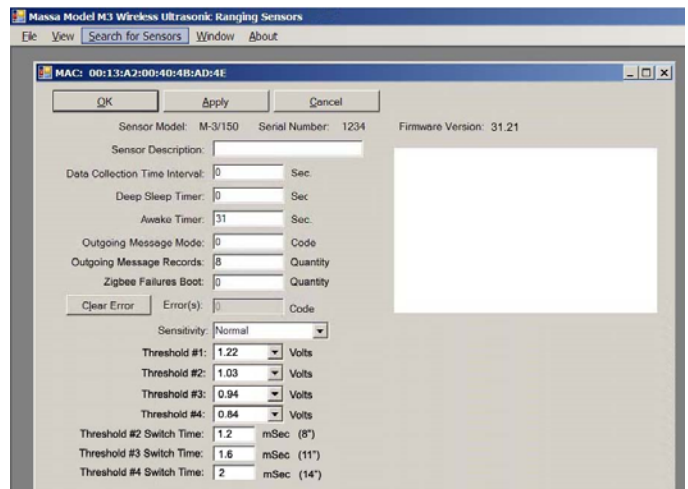

### 13.7 Data Tab

This menu will display the Data History buffer. It will also allow the sensor to acquire the range and status information. You can either acquire and store or not store the data in the sensors history buffer. This data can later be retrieved by clicking the *Get History* button.

Point the sensor at a wall and press either the *Acquire Data Store* or *Acquire Data Don't Store* buttons to obtain the distance to the wall.

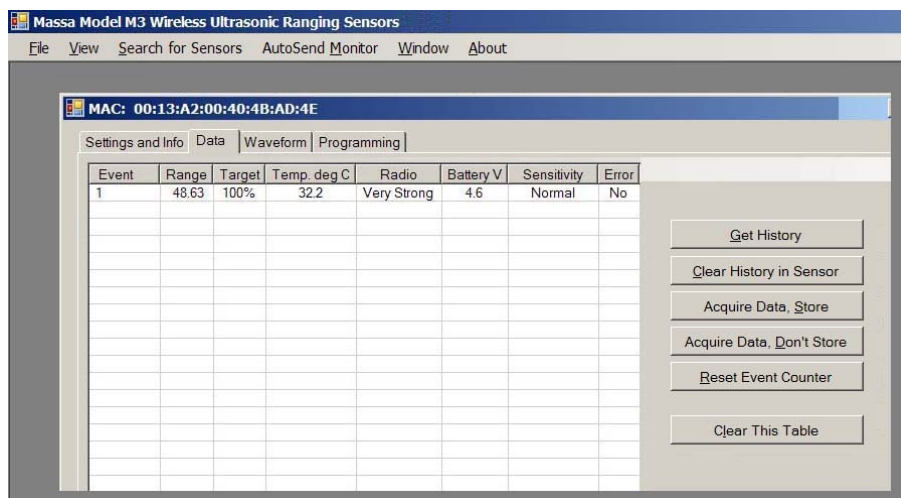

### 13.8 Waveform Tab

This menu will allow you to acquire the ultrasonic waveform that can be used for diagnosing more difficult applications. It is recommended that new applications utilize this feature to record events such as a full tank and an empty tank for archival purposes. Such events could be detected for example when the sensor is mounted near the edge of a tank and a ladder is detected inside the tank after it empties. Recommended plots to record are 1 Transmit Cycle at Low Gain and 10 transmit cycles at High Gain. In a typical plot, the peak signal at the beginning of the waveform is the transmit burst and the 2<sup>nd</sup> peak is the reflection off the target show here 60”.

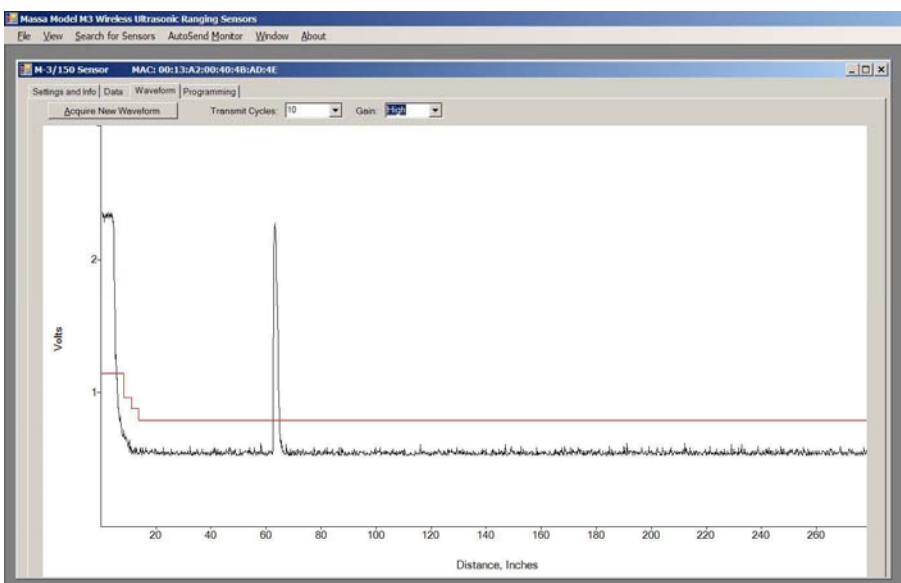

### 13.9 Programming Tab

This tab allows the sensor’s firmware to be upgraded. The latest release SonAire M3 Software will contain the latest release firmware. See <http://www.massa.com> for the latest SonAire M3 Software and firmware releases. Use the Firmware Selection dropdown menu and select the sensor’s correct model firmware. Note that uploading new firmware does not affect the sensor’s configuration registers.

If you require an upgrade of the sensor’s XBee radio firmware, the “Keep Radio Awake 2 Min.” button will be used. See section 13.10 on procedure to upgrade Xbee firmware.

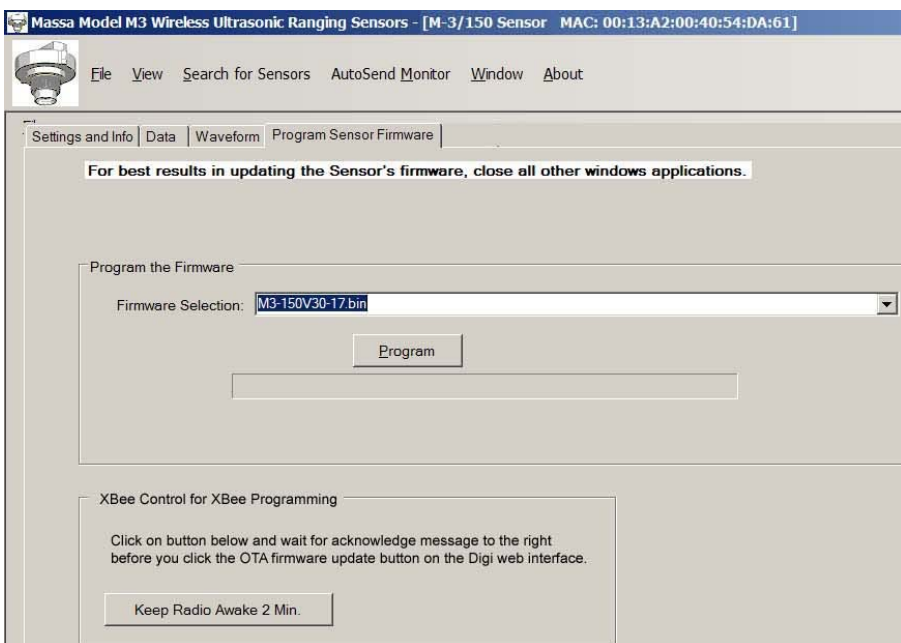

### 13.10 Programming Tab - XBee OTA Firmware Programming

Follow the instructions below to upload the sensor’s XBee firmware. You will need to obtain the firmware from Massa or Digi’s web site before proceeding.

Open up Digi’s web interface selecting the XBee Configuration page. Verify the sensor’s Deep Sleep Timer is set to zero. Click on “OTA Firmware Update Setup” to access this page.

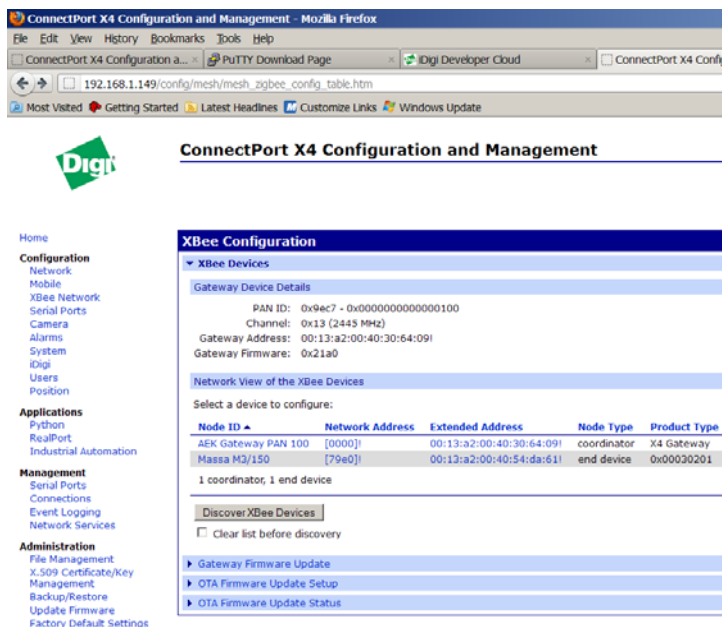

Check the “Enable over the air firmware updates” and click Apply.

Obtain XBee firmware from Massa or Digi. Browse and select the XBee firmware to up uploaded (here it is shown as XBP24-ZB\_29A0.ebl. Click the Upload button.

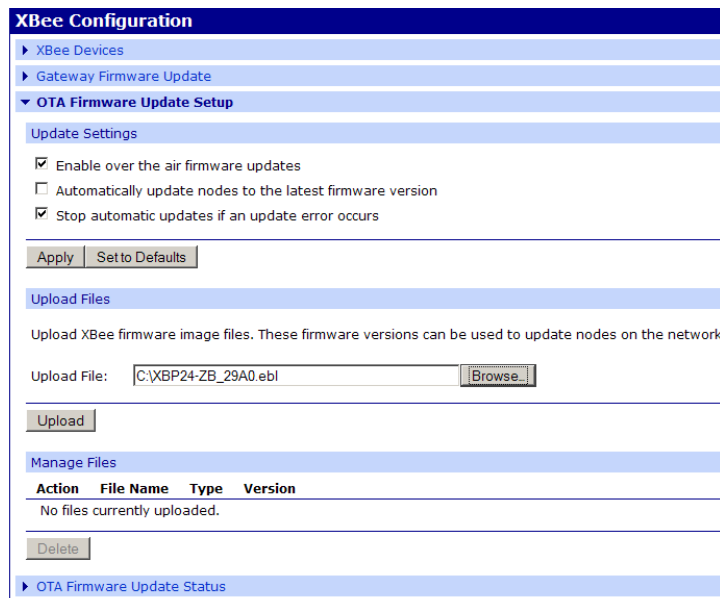

New firmware will be indicated under the Manage Files when upload completed.

Click on “OTA Firmware Update Status” to enter this web interface page.

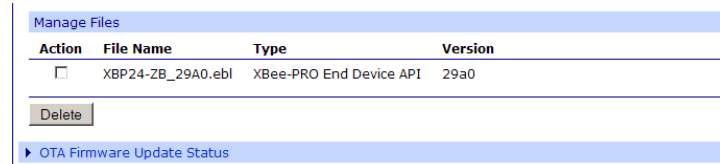

13.10 Programming Tab - XBee OTA Firmware Programming (from previous page)

Prepare this page for XBee FW uploading BUT DON'T CLICK THE "Update" BUTTON JUST YET.

Check the sensor Node, here ending in da61. Next, select the firmware to upload under the "Update selected nodes with firmware file" menu (see here ending in 29A0). Select the gateway under the "Use this router node as the updater". AGAIN, DON'T CLICK UPDATE.

Now go to the SonAire M3 Software application "Program Sensor Firmware" tab and click on the "Keep Radio Awake 2 min" button. Wait for the acknowledge message to the right of the button.

Note: When this feature has been activated, the sensor's LED will blink fast continuously.

Now as soon as possible, click on the Update button on the "OTA Firmware Update Status" page. The Status will indicate "Updating".

Note: You will notice the sensor's LED turn off. It will turn back on when the XBee firmware upload is complete.

When the firmware upload has completed (approximately 1 minute in which the sensor's LED starts blinking), click the Refresh button. The Status indication will report "Complete" and the FW will display the new firmware.

Note: The sensor LED will stop blinking fast after the 2 minute time has expired from the Keep Radio Awake 2 Min button press and will follow to the normal 2 second blink.

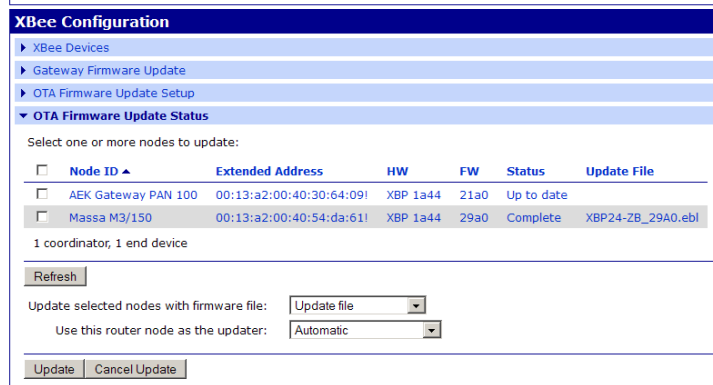
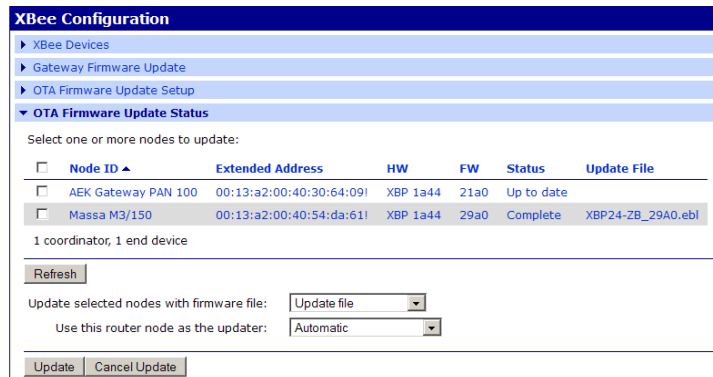
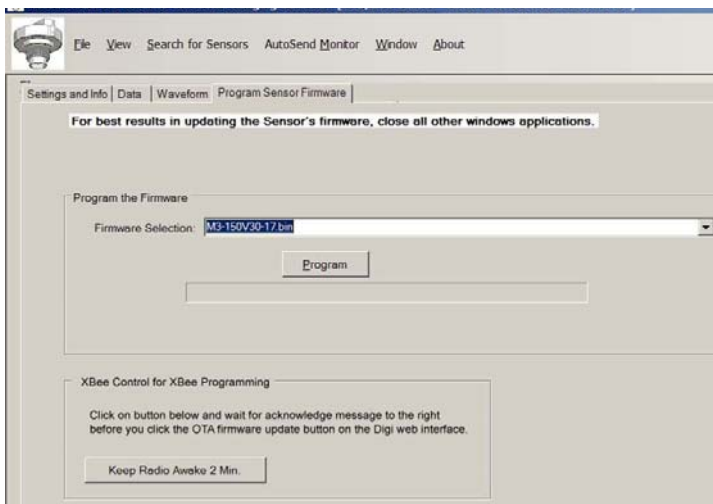
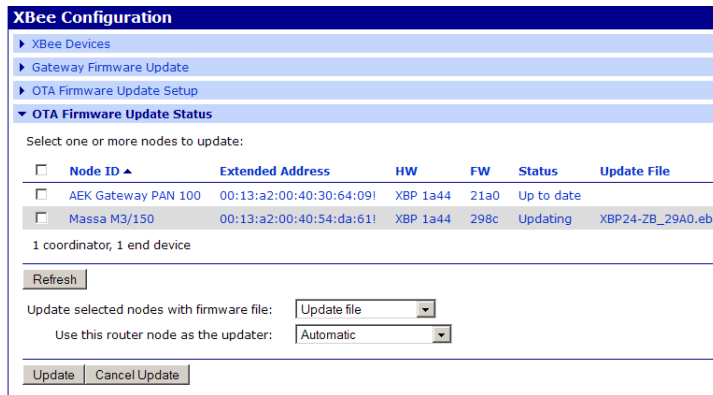

**13.11 AutoSend Monitor Menu**

This menu will allow you to record Command 1 messages sent by the sensor when the sensor is programmed with a non-zero Deep Sleep Timer value and the Outgoing Message Mode register is 1, 2 or 3. The data will be saved as an Excel file with a “csv” extension. As you can see in the example below, the first column is the date and time stamp when the message was received, the 2<sup>nd</sup> column is the MAC address of the sensor, the 3<sup>rd</sup> column is the Event # of the data captured, the 4<sup>th</sup> and 5<sup>th</sup> columns are the Status bytes, the 6<sup>th</sup> column is the capture range to target in inches, the 7<sup>th</sup> column is the temperature in degrees Centigrade, and the 8<sup>th</sup> column is the sensor’s battery voltage.

A Command 1 message will only send a maximum of 8 events of the most recent captured events. Range reported as 510” or greater is an indicator for a cleared record as defined in section 8.2.1.2 where the RangeMSB byte will be 255. In the example below, the real record starts at Event #1 and not at Event #869 due to the range being 510”.

To activate saving Autosend messages to a file, click on the “Enable Data Receiver and Save Data to File” box. You may select “Save Most Recent Record Only” to save the last record from the message or “Save All Data” to save all 8 records from the message.

To gain control of sensors after say a weekend test, use the Deep Sleep Control options to clear the Deep Sleep timer when the sensors wake up after a specified time period (Edit Date and Time box). This will keep the sensor awake allowing access of other sensor features such as obtaining an ultrasonic waveform. This feature is useful when the sensors are being evaluated at a difficult location to access.

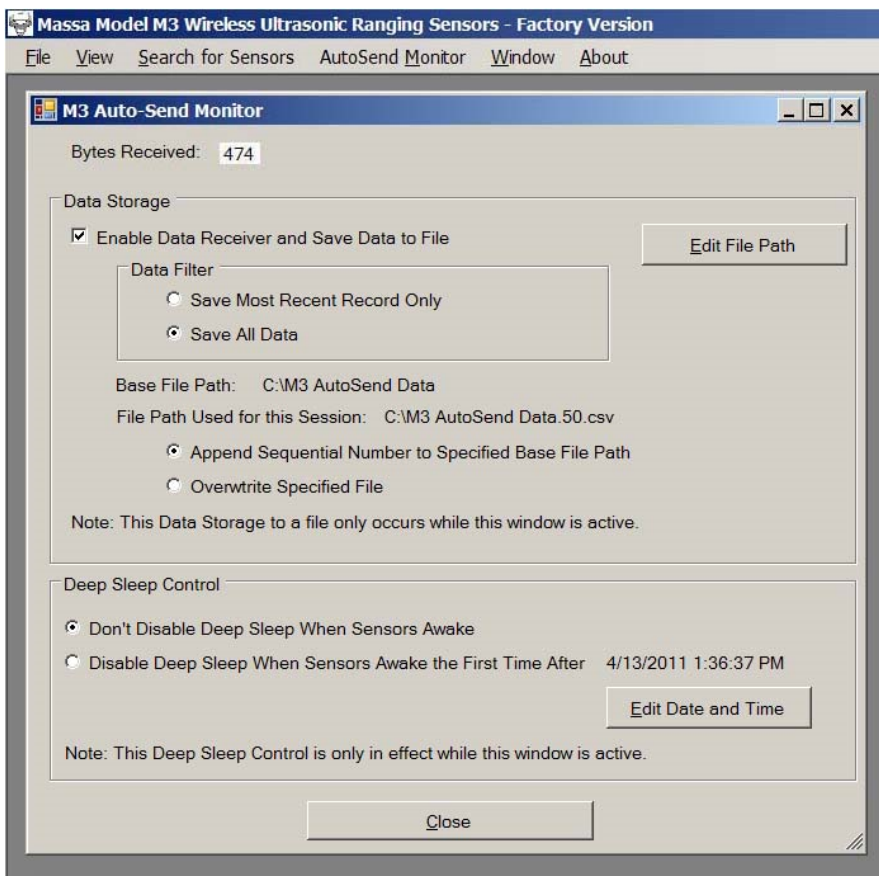

Example of Auto Send messages saved to an Excel file

Date & Time	MAC	Event #	Status1	Status2	Range	Temperature	Battery Volts
12/18/2009 10:00:02 AM	00:13:A2:00:40:48:3B:42	869	67	74	510.219	26.3	5.2
		1	15	74	49.313	23.4	5.2
		2	15	74	38.828	23.4	5.3
		3	15	74	30.336	23.4	5.2
		4	15	74	14.453	23.4	5.2
		5	15	74	5.195	23.4	5.2
12/18/2009 10:00:10 AM	00:13:A2:00:40:4B:AD:4E	16	15	74	46.672	22.2	5.1
		17	14	74	42.5	22.2	5.1
		18	14	74	39.047	22.2	5.1
		19	15	74	33.164	22.2	5.1
		20	15	74	25.875	22.2	5.2
		21	15	74	21.336	22.2	5.1
		22	15	74	14.961	22.2	5.1
		23	15	74	10.5	22.2	5.1

## 14.0 Sensor Installation Example

An application requires the liquid level measurement of a tank recorded once an hour but will only require the data to be retrieved from the sensor every 8 hours. The sensor is to send the data automatically when it wakes up from its Deep-Sleep cycle. Here are the settings to the sensor’s configuration registers:

- 1) Program Data Collection Interval for 3600 seconds or 1 hour (registers 1-3 = 3600 (1 sec units))
- 2) Program Deep-Sleep Timer for 28800 seconds or 8 hours (registers 4-5 = 14063 (2.048 sec units))
- 3) Program Awake Timer to 30 seconds (registers 6-7 = 15 (2.048 sec units))
- 4) Set the Outgoing Message Mode to 2 so that 1 RF packet of the last 8 Events will be sent followed by a duplicate message sent in 15 seconds (1/2 of the Awake timer register value). If gateway disassociates sensor, then first message will be lost but the 2<sup>nd</sup> message will get through.

The sensor will wake up once every hour and will record the range, temperature, status indication, battery voltage, radio signal strength, and event number. Customized python code will be required to accept the incoming messages every 8 hours and sent possibly out through a cell network.

If your data collection rate is more than 8 Events in this example, then you will need to send the “Read History Buffer” message to retrieve the past events after the 8<sup>th</sup> one. This message is to be sent after the automatic message is sent by the sensor and before the sensor goes back to sleep.

IMPORTANT NOTE: For the gateway to retain the sensor on its device list, you will have to program the poll time to a value greater than the sensor’s sleep time.

## 15.0 Miscellaneous Information

### 15.1 Threshold Settings in Massa’s SonAire M3 Software

Here are the settings for both the SonAire M3/150 and SonAire M3/95 used by the SonAire M3 Software. Register 82-86 can be defined as distance with this approximate distance formula:  $distance = x \text{ mS} / 0.147 \text{ mS/in}$

Model SonAire M3/150 (Reg 78-81 Index voltage, see section 9.2.8. Reg 82-87 defined as 0.5 uS units, see section 9.2.9)

Threshold Name	Reg 78	Reg 79	Reg 80	Reg 81	Reg 82-83 [time(mS)]	Reg 84-85 [time(mS)]	Reg 86-87 [time(mS)]
Very Hi	1	0	0	0	2400 [1.2]	3200 [1.6]	4000 [2]
Hi	4	3	2	1	2400 [1.2]	3200 [1.6]	4000 [2]
Normal	8	6	4	2	2400 [1.2]	3200 [1.6]	4000 [2]
Low	14	8	6	3	2400 [1.2]	3200 [1.6]	4000 [2]
Very Low	18	12	8	4	3200 [1.6]	4000 [2]	4800 [2]

Model SonAire M3/95 (Reg 78-81 Index voltage, see section 9.2.8. Reg 82-87 defined as 0.5 uS units, see section 9.2.9)

Threshold Name	Reg 78	Reg 79	Reg 80	Reg 81	Reg 82-83 [time(mS)]	Reg 84-85 [time(mS)]	Reg 86-87 [time(mS)]
Very Hi	1	0	0	0	8000 [4]	12000 [6]	16000 [8]
Hi	4	3	2	1	8000 [4]	12000 [6]	16000 [8]
Normal	8	5	2	1	8000 [4]	12000 [6]	16000 [8]
Low	14	6	4	2	8000 [4]	12000 [6]	16000 [8]
Very Low	18	12	7	3	8000 [4]	12000 [6]	16000 [8]

Model SonAire M3/50 (Reg 78-81 Index voltage, see section 9.2.8. Reg 82-87 defined as 2 uS units, see section 9.2.9)

Threshold Name	Reg 78	Reg 79	Reg 80	Reg 81	Reg 82-83 [time(mS)]	Reg 84-85 [time(mS)]	Reg 86-87 [time(mS)]
Very Hi	10	7	4	1	8000 [16]	12000 [24]	16000 [32]
Hi	12	8	6	2	10000 [20]	14000 [28]	18000 [36]
Normal	14	9	6	2	12000 [24]	16000 [32]	20000 [40]
Low	19	13	7	3	12000 [24]	16000 [32]	20000 [40]
Very Low	22	17	11	6	16000 [32]	20000 [40]	24000 [48]

**15.2 Minimum Sensing Distance over Higher Temperatures**

Temperature that exceed values indicated below will pose a slight variance in reporting a linear measurement when target approach the indicated minimum distances. NOTE: The sensor’s reported range will be the minimum specified distance when the target is at this distance. This table will aid in determining the performance when using the extended blanking distance to add to these factory default values (see section 9.2.4).

Temperature	SonAire M3/150 & M3/150is Min Sensing Distance	SonAire M3/95 & M3/95is Min Sensing Distance	SonAire M3/50 Min Sensing Distance
< 25°C	4.25”	6”	12.5”
25°C to 40°C	4.5”	7.1”	12.6”
40°C to 50°C	4.75”	9.4”	12.8”
50°C to 60°C	5.0”	10.3”	13.0”
≥ +60C	5.25”	11.5”	13.2”

**15.3 Battery Life and Suggested Replacement Voltage**

Below are the battery life estimates using Energizer L91 batteries with the data acquisition rate programmed to the same time as the wake up time. Status messages will include reporting the battery voltage. It is suggested to replace all three batteries when the sensor reports back with voltages below 3.9V.

	Wake up and report status rate						
	24 hrs	12 hrs	8 hrs	6 hrs	4 hrs	1 hrs	1 min
<b>Battery life at 80% battery efficiency</b>	3.63 yrs	3.60 yrs	3.58 yrs	3.56 yrs	3.52 yrs	3.17 yrs	4.36 months

To replace batteries, open cover using slotted screwdriver and remove existing batteries. Press commission button to discharge any residual voltage and then install batteries in polarity shown in battery holders, see photo to right below. Close and secure the cover. For your convenience, the MAC address for the sensor is on the outside cover by the hinge.

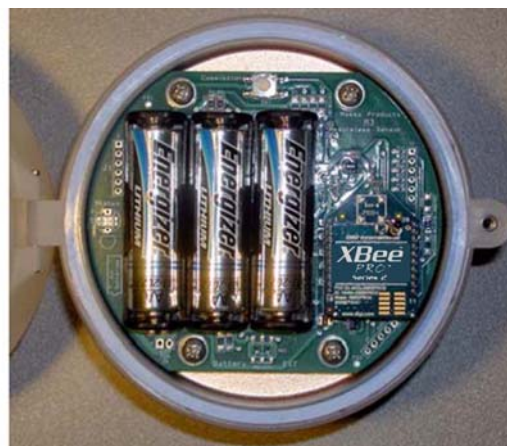

**15.4 XBee radio settings (from default)**

- Xbee radio version 29A0 or greater
- Scan Channels (SC) = 0x1ffe
- Node Identifier (NI) = Massa SonAire M3/xxx (this is specific to sensor model type)
- Device Type Identifier (DD) = 0x30201
- Node Discovery Option (NO) = 1
- Sleep Mode (SM) = 1 – Pin Hibernate
- Poll Rate (PO) = 0
- Associated LED Blink Time (LT) = 0x0A